



Stereo internet radio

WR-860

User Manual



Please read this user manual carefully before using the receiver

Contents

Location of Controls	4
Remote control	7
Entering security code for your wireless network	8
1. Getting started	10
2. Network Setup	11
3. Overview of features and functions	12
4. Internet Radio	13
5. Media Centre	15
6. DAB+/DAB Radio	16
7. FM Radio	17
8. Bluetooth playback	18
9. AUX-IN	19
10. USB Playback	20
11. Micro SD playback	21
12. Alarm Setting	22
13. Sleep Timer Setting	23
14. Configuration	24
15. Remote control via PC / Smart phone	
- Tuning internet radio & manage favourite	29
16. Trouble Shooting	32
Helpful Tips	34
Technical Specification	35

Location of Controls

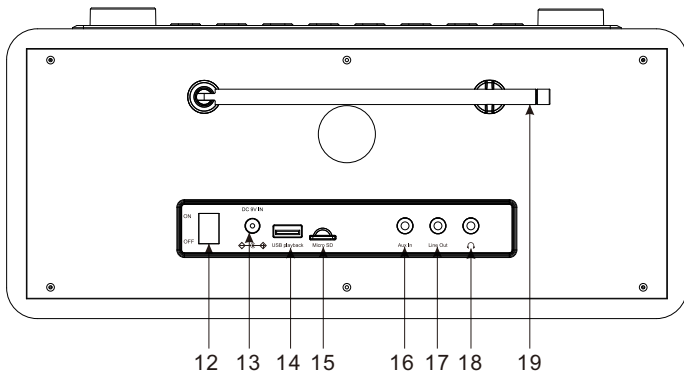
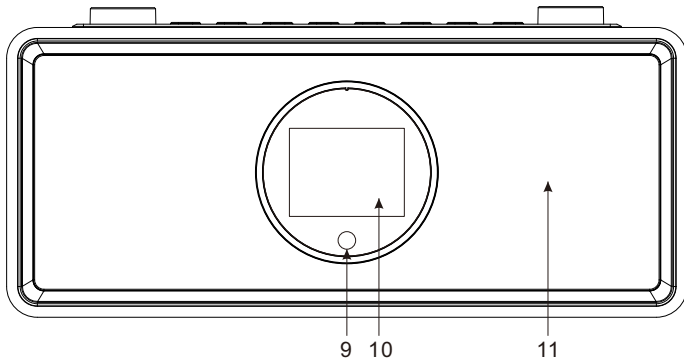
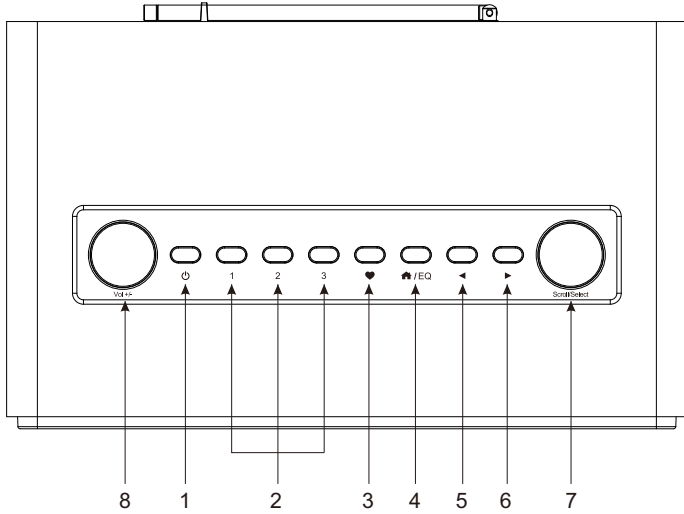

Location of Controls

1.

Press and release to Standby / activate the radio

2. **Quick preset buttons 1-3**

Long press to preset a particular station. Short press to recall the station.

3.

Long press to preset a particular station

Short press to recall the favourite list

4. /EQ

Access Home screen / toggle to return to the now playing screen. Long press to access EQ setting.

5.

Back to previous menu.

[Internet radio / DAB / FM]

Short press to return to the last level of the menu.

Long press to skip to the previous presets / station

[Media player: UPnP / USB / Micro SD]

UPnP / Micro SD: Short press to return to the list of media files.

USB: Short press return to Home.

[BT]

Long press to exit the BT mode.

6.

[Internet radio / DAB / FM]

Under the radio playing display, short press repeatedly to view the radio info/display the big time clock.

Long press to skip to the next station/presets.

Under My Favorite list, short press to enter edit menu

[BT]

Long press to disconnect the paired device.

7. **Scroll / Select**

Rotate to scroll along, up/down on the menu

Press in to confirm / Select menu options

[FM]

Rotate the knob to manual tune the FM frequencies.

[Internet radio / DAB]

Rotate to change to next / previous station.

[Media player UPnP / BT / USB / MicroSD]

Rotate to skip to next or previous track.

Press in to pause/play the music

Location of Controls

8. Vol +/-

Rotate to adjust the volume level. Press in to Mute.

9. Remote sensor

10. Color display 2.4"

11. Speakers

12. Power on/off switch

13. DC IN Jack

14. USB port - for playback only

15. Micro SD memory card slot















16. Aux in

17. Line out

18. Earphone jack 3.5 mm

19. Telescopic antenna

Remote control

1.  : Press to toggle between Standby and Operation
2.  : Mute
3. **0-9**: Input index number on the list / input characters for WiFi password
4.  : Preset the current playing station to Favorite
5.  : Cursor up
6.  : Cursor left / back to previous menu
7.  : Alarm button
8.  : Sleep Timer
9. **Mode**: Switch between radio modes
10.  : Home
11.  : Previous station on the list/previous track on media sources
12. **Local**: Access the local station list
(Local area set up in Configuration)
13.  : Recall the favorite list
14. **OK**: confirm button
15.  : Cursor right
16.  : Cursor down
17. **Vol+**: Volume up
18. **Vol-**: Volume down
19. **EQ**: Equalizer
20.  : Next station on the list/next track on media sources
21.  : Play/pause for media sources
Play/stop for Internet radio
22. **Dimmer**: Access the Dimmer menu to adjust the brightness of the display
23. **Info**: Quick access to Network and System information



Entering security code for your wireless network

Using remote control

On the alpha-numeric keypad, press the button repeatedly to cycle through the characters assigned to each button. Refer to the following list. To input a character, highlight it and press the **[OK]** button to confirm and input the next character. When it comes to the last character of the password, press and hold **[OK]** to complete the entry.

Button 1: 1 and different kind of symbols !@#\$%^&*()_+[]{};:'"\,./<>?

Button 2: 2ABCabc

Button 3: 3DEFdef

Button 4: 4GHIghi

Button 5: 5JKLjkl

Button 6: 6MNOmno

Button 7: 7PQRSpqrs

Button 8: 8TUVtuv

Button 9: 9WXYZwxyz

Button 0: 0

Using control button on the radio unit

Use the **[Scroll/Select]** knob to scroll through the characters, highlight it and press **[Scroll/Select]** knob to confirm and input the next character. When it comes to the last character of the password , press and hold **[Scroll/Select]** knob to confirm and complete the entry.

Note: The password is case sensitive.

Before you start

Please ensure the following is ready:

You have a broadband internet connection.

A wireless broadband router is connected to the internet successfully. The radio supports Wireless B, G and N connection (Wireless N router can also be used with the setting on B or G). You know the Wired Equivalent Privacy (WEP) or Wi-Fi Protected Access (WPA) data encryption code/password. You need to key in the correct code when the radio is connected to the wireless router for network connection. If you do not know the code/password, please contact the person/technician who set up the router/network for you.

The radio can work via Wireless network connection (Wi-Fi connection).

Precautions

- The radio should not be used in a high temperature or high humidity environment over prolonged periods of time as this may damage the unit.
- Keep the radio away from liquids as it may get damaged. Please switch off the radio immediately if water or liquids is spilled into the radio. Consult with the shop you bought this radio for any question.
- Avoid using or storing the unit in dusty or sandy environment.
- Do not open and repair the radio by yourself.
- Use only the specified power input voltage to power up the radio. Connecting a power supply with a different rating will cause permanent damage to the radio and may be hazardous.
- Clean only with dry cloth.

WARNING: TO PREVENT FIRE OR ELECTRIC SHOCK HAZARD, DO NOT EXPOSE THIS PRODUCT TO RAIN OR MOISTURE.

CAUTION

**RISK OF ELECTRIC SHOCK
DO NOT OPEN**

CAUTION: TO REDUCE THE RISK OF ELECTRIC SHOCK, DO NOT REMOVE THE RADIO BACK. NO USER SERVICEABLE PARTS INSIDE. REFER SERVICING TO QUALIFIED SERVICE PERSONNEL.



THE LIGHTNING FLASH AND ARROWHEAD WITHIN THE TRIANGLE IS A WARNING SIGN ALERTING YOU OF "DANGEROUS VOLTAGE" INSIDE THE RADIO.



THE EXCLAMATION POINT WITHIN THE TRIANGLE IS A WARNING SIGN ALERTING YOU OF IMPORTANT INSTRUCTIONS ACCOMPANYING THIS RADIO.

1. Getting started

The radio is powered by the mains adapter. A 9V 2A external power adapter is included. Connect the power adapter to the radio and the mains socket.

Switch on the power switch at the rear side of the radio. The display will illuminate.

2. Network Setup

Internet connection can be setup via Wireless network (WiFi). Your radio requires a broadband Internet connection.

- If this is first time use, the Configure Network wizard will be displayed. Choose Yes to start configuring network. Press the [◀] button to highlight Yes and press [**Scroll/Select**] to confirm.

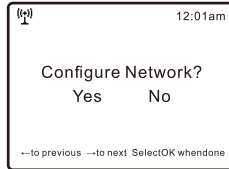

- Select Add/Remove AP from the list, use the [**Scroll/Select**] knob to scroll and press it to confirm, then choose Add AP (Scan):

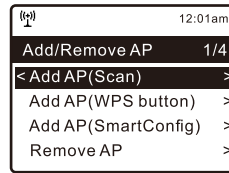
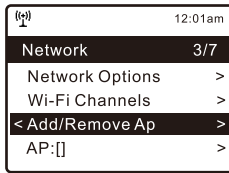

- It will start scanning the Wi-Fi networks available. Scroll to your network and press [**Scroll/Select**] to confirm. If your wifi network has a password protected, it will ask you to enter the passphrase / password. Please refer to the above section 'Entering security code for your wireless network' on P.8.

Note: The password is case sensitive. Please consult with the one who setup your network if you don't know the password.

- When the Wi-Fi connection is successful, the Association Complete will be shown briefly. The wifi signal bar will appear on the top left corner of the display:

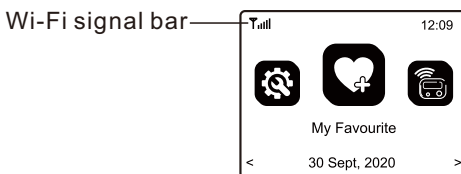

3. Overview of features and functions

Press [**▲/EQ**] to enter the Home screen. Scroll by rotating the [**Scroll/Select**] knob or the [**▲ ▼ ► ◀**] button on remote to see the operating modes available:

My Favorite — To show the list of favorite stations which have been assigned to the presets. There are up to 150 presets available.

Internet Radio — Start exploring the worldwide radio stations and music here.

Media Centre — You can browse and stream music via UPnP or DLNA Compatible devices in the same network of the radio.

DAB+/DAB Radio — Pick up DAB+ and DAB radio signal if available in your local area (no internet connection required).

FM Radio — Receive ordinary FM radio stations in your local area (no internet connection required).

Bluetooth — Bluetooth playback, to play audio streamed (receive) from another Bluetooth enabled device after pairing/connected each other.

AUX-IN — Plays music from external media devices by connecting to the Aux-in jack.

USB — Plays music from USB thumb drive

Micro SD — Plays music from Micro SD memory card

Alarm — Alarm clock. Two alarm settings available.

Sleep Timer — Enable the timer to turn the radio in standby after the selected time elapsed.

Configuration — More options/settings available to personalize as you desire.

4. Internet Radio

Press Home button, choose **Internet Radio** and you will find the options below:

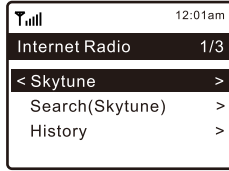

Skytune

Select Skytune to start enjoying thousands of radio stations over the world. You can filter your search by Region, Music genre and talks. The **Local Radio** let you access quickly the stations available in your local area through internet connection.

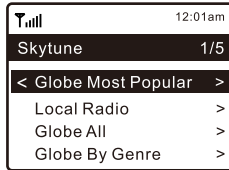

Note — You can change the Local Radio area under **Configuration> Local radio** setup. Please refer to section 14 for the details.

When you scroll along the list of **Globe All** and want to quickly reach to a certain point of the long list, input the index number on the remote control to quickly jump to that point. For example, on the remote control, input 2 8 and press OK, it will highlight the station no. 28.

Search

Instead of browsing the radio station list, you can input a few characters of the desired station to filter out / short list the stations.

History

The radio memorizes the stations you have listened up to 99 stations. If you have listened more than 99 stations, it will supersede the first station that you have listened.

Start playing internet radio

When a radio station starts playing, more radio information can be displayed. Press the ► button in the state of the playing screen below:

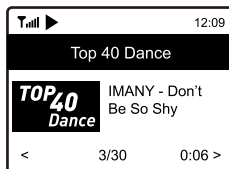

4. Internet Radio

Every time you press the ► button, it will toggle between the big clock and the radio channel information:

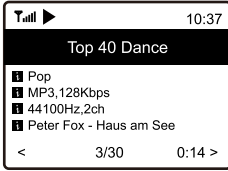

My Favorite

This is to show the list of your Favorite stations which have been assigned to the presets.

Preset a station

When a radio station is playing, press the button on the remote control or press and hold the on the unit, you will see the icon appears as below. It means the station is added to the Favorite list.

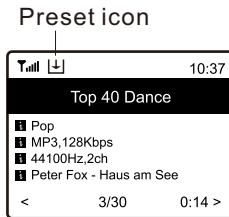

The new added station will always show in the last item on the Favorite list. You can store up to 150 presets.

Recall a station

Press the button on the remote control or press the briefly on the radio unit to recall the list of presets, or navigate to **My Favourite** on the Home screen and select it to confirm.

Edit your favorite list

On the Favorite list, choose the radio station you want to edit then press the [►] button on the remote control (or press [►] on the unit). It will enter the Edit menu with the following options:

- Move down — To move down the ranking of a station
- Move up — To move up the ranking of a station
- Delete — To delete a particular station
- Move to top — To move the station to the top of the favorite list.
- Move to bottom — To move the station to the bottom of the favorite list.

5. Media Centre

The device supports UPnP and is DLNA-compatible.

This provides the opportunity to stream music from your network. However, this requires you to have a compatible device in your network that can function as a server. This can be e.g., a network hard drive or a conventional PC with e.g., Windows 8 via which access to the shared folder or media sharing is permitted. The folders can then be browsed and played on the radio.

Note — Please make sure your computer laptop is on the same Wi-Fi network as the Radio before you start using this function.

Music streaming

- Once the UPnP/DLNA compatible server is configured to share media files with your radio, you can start music streaming.
- On the main menu, select **Media Centre and choose UPnP**.
- It may take a few seconds for the radio to complete the scan for available UPnP servers. If no UPnP servers are found, it will show **Empty List**.
- After a successful scan is done, select your UPnP server.
- The radio will show the media categories available from the UPnP server, e.g. 'Music', 'Playlists' etc.
- Choose the media files that you wish to play.

You can set the mode of playback under **Configuration > Playback setup**.

My Playlist

You can make your own playlist for the UPnP music files. Choose and highlight the song you want to add to playlist, press and hold the [♥] button or press the ♥ button on remote, until the sign ⊣ appears. The song will be added to My playlist.

Clear My Playlist

Remove all songs in “My Playlist” to allow a new playlist to be prepared.

Note — If you have DLNA compatible servers available, follow the steps described above to browse the audio files from DLNA compatible device on the radio to play.

6. DAB+/DAB Radio(Digital Audio Broadcasting)



If there is Digital Audio Broadcasting (DAB) in your area, the Radio can pick up the DAB stations as well (no internet connection is required). The Radio supports both DAB and DAB+.

Place the Radio close to the window and extend the antenna as far as it can go to get the best reception. Sometimes you may need to adjust the direction of the antenna to improve reception.

Press the Home button, scroll to **DAB Radio** or use the **[MODE]** button on remote to switch to DAB Radio. Press **[OK]** to start.

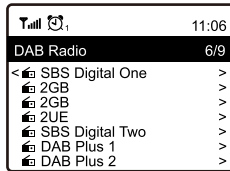
Choose "DAB Full scan" to start scanning. When it is done, a preset page will be displayed for your action.



You can select the channel and start listening to it. Whenever you want to add to **My Favourite**, press the  button on remote or press and hold the  button on the radio, and it will add to the favourite list.

Always press the [◀] button to return to the Preset list.

Note — When a DAB radio is playing, press the [▶] button to view more radio information, each time you press the [▶] button, it will display various information at a time such as radio frequency, rolling texts (if available) and big time clock.



New digital radio stations should be picked up automatically by the radio if they are part of a multiplex you already received. Otherwise you need to do the Preset Scan again.

7. FM Radio

To receive the ordinary FM stations (no internet connection is required), place the radio close to the window and extend the antenna as far as it can go to get the best reception. Sometimes you may need to adjust the direction of the antenna to improve reception.

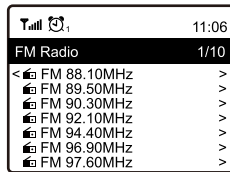
On the Home screen, scroll to FM Radio or use the **[MODE]** button on remote to switch to FM Radio. Press **[Scroll/Select]** knob (or **OK** button on remote) to start. Choose "FM full scan" to start scanning. When it is done, it will automatically save the found channels on presets and display the list for your action.



You can select the channel and start listening to it. Whenever you want to add to **My Favourite**, press the  button on remote or press and hold the  button on the radio, and it will add to the favourite list.

Always press the **[◀]** button to return to the Preset list.

Note – When it is playing FM radio, press the **[▶]** button to view more radio information, each time you press the **[▶]** button, it will display various information at a time such as radio frequency and big clock display.

Manual Tune

To manual tune a frequency, rotate the **[Scroll/Select]** knob.

8. Bluetooth playback

Before transmission between your Bluetooth device and the radio is possible, both devices must be coupled. This process is called "pairing". The radio is served as a receiver, to receive music stream to play on the radio.

If you have already coupled to a Bluetooth device before, this connection will be restored automatically when both devices are in range and Bluetooth operation has been selected on the radio. "Pairing" does not have to be repeated. This function may need to be activated in your Bluetooth device, however.

- Push the Menu button to display the selection menu for the different operating modes.
- Use the up/down button to select the operating mode Bluetooth and push the dial switch.
- Switch your Bluetooth device to which you want to connect the radio on and activate the pairing mode here. The device scans for Bluetooth devices in the reception range.
- When the radio is found, your bluetooth device shows its name WR-860-XXXX (the XXXX is an identification code for your radio unit).
- Select the radio at your bluetooth device.
- Start playback on your bluetooth device.
- Playback now takes place using the radio.

9. AUX-IN

You can listen to the music from other media device or smart phone through the connection to the 3.5 mm aux-in jack on the rear side of the radio.

Use the cable with both ends in 3.5 mm pin, connect one end to the aux-in jack on the radio, the other end to the headphone jack on the media device or if it has a line out socket.

10. USB Playback

Another option to listen to your favorite music is via the USB thumb drive. Insert the USB drive to the port at the back of the radio. Press the Home button and navigate to "USB", press OK to confirm. It will take a moment to read the USB drive before it starts playing the music.

Skip the next or previous track by rotating the [**Scroll/Select**] knob.

To pause/play the music, press in the [**Scroll/Select**] knob.

Note:

If a USB thumb drive is not recognized, the list of files on the drive is corrupted or a file in the list is not played, please connect the USB drive to a PC, format the device and try again. The supported file system is FAT16 and FAT32.

A USB drive requires high power (more than 500mA or 5V) is not supported.
Compatible audio format: MP3

11. Micro SD playback

To play music from a Micro SD memory card, simply insert a micro SD card into its port on the front of the radio (with label side up). Press the Home button and navigate to "Micro SD", press OK to confirm. It will take a moment to read the micro SD card before it can begin playing music.

Skip the next or previous track by rotating the [**Scroll/Select**] knob.

To pause/play the music, press in the [**Scroll/Select**] knob.

Note: If a micro SD is not recognized or does not play properly, the list of files on the device is corrupted or a file in the list is not played, please format the memory card (all the files will be deleted) and try again. The supported file system is FAT16 and FAT 32.

Compatible audio format: MP3

12. Alarm Setting

- Press the Home button, navigate to Alarm and press OK. press the [] button on the remote control.
- Select either Alarm 1 or Alarm 2, choose Turn on to activate the Alarm.
- Follow the alarm wizard instructions to set the alarm.
- The wizard will guide you through the settings below:

Time — Set the time for the alarm

Sound — You can choose **Wake to Tone, My Favourite, Wake to FM Radio or Wake to DAB Radio** or other media players as the alarm source.

Note — Wake to FM or Wake to DAB Radio - only the preset stations can be used for the radio alarm (if the preset scan has been completed).

Wake to My Favourite — Please preset your favorite station before setting this as the alarm source.

Repeat — You can schedule the alarm as you desire -Everyday, Once or multiple days.

Alarm Volume — Adjust the volume of the alarm as you like by rotating the [**Scroll/Select**] knob or [**▲/▼**] button on remote.

Alarm duration — There are number of duration choices available. You can set the preferred duration for the alarm to sound. When the time is due, it will turn off automatically.

- After the above settings are completed, press the [] button to exit and make sure the Alarm is turned on. You will see the Alarm icon appeared on the display if it is activated.

Note: If the selected alarm sources are not available, the wake to Tone will be released.

Stopping the Alarm/Activate the Snooze function

When the alarm goes off, press the [] to stop the alarm or press in the [**Scroll/Select**] knob to activate the Snooze feature.

When the Snooze is activated, the alarm is muted for 9 minutes and sounds again when the time is due. You can repeat the process multiple times. To stop the "Snooze" function, press the [] .

13. Sleep Timer Setting

You can set the timer to let the radio goes standby after the selected time elapsed in the range of 15 minutes to 180 minutes. There are several timer options to choose from.

Press [**zzz**] button on the remote control to set the timer, or navigate to Sleep Timer option on the main menu.

You will see the icon appeared on the display if the timer is set.

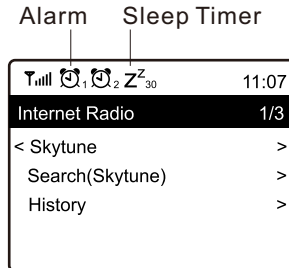

14. Configuration

Here you will find the complete settings / options available to configure your own radio. On the main menu, navigate to Configuration setting. Press OK and you will see a list of options available.

Network

Network Options

Always on: The WLAN function remains switched on (faster access when switching from other modes of radio).

Auto off in 30s: The WLAN function shuts down after 30 seconds when not in use (to save energy).

Wi-Fi Channels

Not all of the Wi-Fi channels are available in every country. There may be variation between different countries. Therefore it is necessary to choose the Wi-Fi channels to ensure the Wi-Fi performs satisfactorily. We have already set the channels according to the requirement in different countries. Choose the country you are staying from the list to get the correct channel.

Add / Remove AP

Add AP (Scan) — It will scan out a list of routers around.

Add AP (WPS button) — Choose this option to connect your Wi-Fi router via WPS if the router has a WPS button.

Remove AP — If you have already added a router and want to remove it, choose this option.

Note — Always bring the radio within 2 meters of the Wi-Fi router for setup.

AP: []

If you have added more than one routers on the radio and want to switch to another one, select this option to change.

Signal

This is to show the strength of the Wi-Fi Signal of the Wi-Fi router as received by the radio. Usually signal levels lower than -70dBm is at weaker level and if it affects the reception of your radio, you may need to optimize the router location or check any problem of the router itself.

IP

The IP is set Dynamic by default. Select to change Fixed IP according to your network condition.

DNS

The DNS is set Dynamic by default. Select to change <Fixed> DNS according to your network condition.

14. Configuration

Date and Time

The radio will set your local time automatically after the internet connection is completed. If you want to do manual setting, change it by the following options:

- **Time zone**

Auto-set Time Zone: This option is set by default.

Manual-set Time Zone: Choose this option if you want to set the time in another region.

Choose and highlight the region/city you prefer and press OK to confirm.

Coupled with NTP (use network time) and DST (Daylight time saving) will be adjusted automatically if you choose to use network time (NTP).

- **Set Time Format**

Choose either 12-hour or 24-hour notation you prefer.

- **Set Date Format**

- **DST (Day Light Saving)**

Enable on/off

- **NTP (Use network time)**

NTP is designed to synchronize a device's clock with a time server. Your radio will synchronize the time server by default every time it powers up and connects to Internet. This ensures a very high degree of accuracy in the radio's clock. You can change to use other time server by inputting the URL address (see below NTP server). You can choose "Do not use network time" if you don't want it to.

If you choose not to use NTP for clock synchronization, highlight the NTP (Network time protocol) and press OK to make the change. You will see the Set Date & Time appeared on the menu. Select it and adjust the date and time as you desire.

- **NTP Server**

NTP is designed to synchronize a device's clock with a time server. Here it shows the server being used for the radio.

- **Set time from DAB**

When the DAB radio is selected, the time will be synchronized with the DAB time.

- **Set time from FM**

When the FM radio is selected, the time will be synchronized with the FM time.

14. Configuration

Language

The default language is English, you can choose other languages as preferred. Scroll with the ▲ ▼ buttons on remote or **[Scroll/Select]** knob to the item with  and press **OK**. Scroll to highlight and press **OK** to select your language of choice. English, French, Spanish, Italian, German, Dutch, Polish, Russian and more are available.

DAB set up

• DAB full scan

You can always carry out a new scanning of DAB channels by selecting this option. All current presets and channels will be erased.

• DAB manual tune

This is to show the number of stations and signal received of each DAB frequency.

• DAB station list

The scanned DAB stations will be listed here for management. You can move the position or even delete any station. Scroll to the station and press **[▶]** button. A pop up window will be presented: Move up, Move down and Delete.

FM Setup

• Scan setting

Either "All stations" or "strong stations" (with stronger signal) can be selected for the scan.

• Audio setting

You can choose to set "Auto Stereo" or "Forced mono" for the reception.

• FM full scan

You can always carry out a new scanning of FM channels by selecting this option. All current presets and channels will be erased. The radio at the lowest frequency of the scanned values will be highlighted. The preset list will be saved unless a new preset scan is carried out.

• FM station list

You can adjust the preset ranking by Move down, Move up or Delete it. Highlight one of the preset, then press the **[▶]** button, it will enter into the Edit menu.

Always press the **[◀]** button to return to the Preset list.

Local Radio

The radio is set by default to detect the radio stations in your local area automatically through internet connection and these stations can be accessed by a press of **[LOCAL]** button on remote. You can also set Local

14. Configuration

in another region if you want. Highlight the Local Radio and press **OK**. Choose **Manual-set Local radio** to change the region setting.

Playback Setup

This is to set the mode of playback under UPnP/DLNA compatible streaming: Repeat All, Repeat One, Shuffle and Normal.

Resume play options

This is to set the device whether to return to the last operating mode when it is switched on or displays the Home screen.

Power-On Options

This is to select the state of the radio after a power reset or power cut, whether to return to Standby or the state subject to the option selected from the "Resume play options".

Dimmer

You can set the backlight level for the display as you prefer.

There are two settings: Mode and Level

• Mode — Normal or Power Saving

Normal — the display will stay with the same level of brightness all the time without dim down.

Dim — the display will dim down after 20 seconds if no operation is made on the radio.

• Level — Bright and Dim

Bright — This is to adjust the level of brightness in Normal mode.

Dim — This is to adjust the level of brightness in Dim mode.

• Dimmer in Standby

The display brightness in standby mode can be adjusted manually by turning the rotary knob [**Scroll/Select**] or press the ▼ ▲ buttons on remote. If no action taken in 20 seconds, it will restore to the dim value as set in Configuration.

EQ(Equaliser)

Various music genres can be set.

Buffer Time

Sometimes you may experience uneven playback of the internet radio. This can happen if the internet connection is slow or network congestion occurs.

To help improving the situation, you can choose longer buffer time to get a few seconds of radio stream before beginning to play.

The default value is 2 seconds. You can choose 5 seconds if you prefer to have a longer buffering time.

14. Configuration

AUX in Gain

If the volume level of the connected auxiliary device is too small even the volume on the device is set to maximum, you may want to adjust the gain to 6dB to achieve a higher volume level.

Information

View the Network and System Information of your radio.

To access quickly to this information, press the [Info] button on the remote control.

When you use your PC to manage the My favorite stations, you have to use the IP address and you can view this info from here. Then type in the IP address (Configuration > Information > Network-Information > IP) to your PC's browser input window

Software Update

There may be software release to upgrade features of the radio from time to time. Check the update regularly to keep your radio up to date with the latest software.

Reset to Default

You can do the reset to clear all the settings and return to default settings.

**Please note all the Station presets, Settings and configuration will be erased after you have performed the Reset.

15. Remote control via PC / Smart phone – Tuning internet radio & manage favourite

Experience an easy way to control tuning internet radio channels and manage your favourite list via PC or Smart phone's web browser.

The supported browsers are Internet Explorer and Chrome.

- Connect your PC or Smart phone to the same Wi-Fi network as your radio.
- Visit **www.skytune.net**
- On the home page, click “Browse/Search”

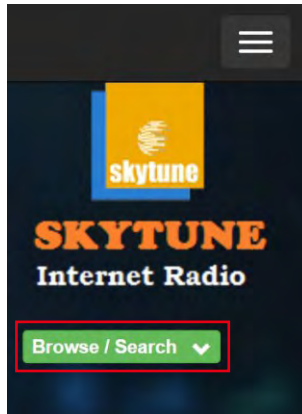

- Browse or enter the name to search the radio channel, a list of internet radio channels will be displayed.
- Click the “ ♥ ”symbol

Result for Searching 'dance'



1.fm 90's
Dance



1.fm Dance
One



101.RU - Club
Dance



101.RU -
Russian Dance



15. Remote control via PC / Smart phone – Tuning internet radio & manage favourite

- It will prompt you whether to "Add Favourite" or "Listen to Station". Enter the IP address of your radio (e.g. 192.168.1.11):

Add Favourite / Listen to Station

Which operation do you want to apply to the station ?

1.fm Dance One

- Add station to my radio device favourite
- Listen to station on my radio device

Please enter your radio device's IP below.

192 . 168 . 1 . 11

Send

Close

The IP address can be located on the radio unit as follow:

- * On the remote control, press the **[INFO]** button, choose Network and scroll to IP to view the IP address
- * On the radio, return to the main menu. Navigate to **Configuration > Information > Network Information > IP**

- Select "Listen to Station", click "Send" and the radio unit will switch playing the channel and the "My Favourite" page will pop up on the web browser.

You can then choose to add the playing station to favourite or manage your list by other edit options. Any changes will synchronize to the radio unit immediately.

15. Remote control via PC / Smart phone – Tuning internet radio & manage favourite

MY FAVOURITE

Channel Group : E00T

	Channel Name	URL							
1.	DJ AAM Radio FM	*****	Edit	Delete	Top	Up	Down	Bottom	
2.	Country Radio Switzerlar	*****	Edit	Delete	Top	Up	Down	Bottom	
3.	Bigbeat	*****	Edit	Delete	Top	Up	Down	Bottom	
4.	24Radio Switzerland	*****	Edit	Delete	Top	Up	Down	Bottom	
5.	AFN American Freedom	*****	Edit	Delete	Top	Up	Down	Bottom	
6.	Energy Berlin	http://energyradio.de/bremen	Edit	Delete	Top	Up	Down	Bottom	
7.	MP3 Pro	http://www.katrafm.com/katrafm_mp3pro.m3	Edit	Delete	Top	Up	Down	Bottom	
8.	2	http://www.ultranet.biz/vegasandanski.m3u	Edit	Delete	Top	Up	Down	Bottom	
9.	stream 2	http://lindowsradio.com:8600/listen.pls	Edit	Delete	Top	Up	Down	Bottom	
10.	aac 128	http://eastlondonradio.com:8100/bighigh.aac	Edit	Delete	Top	Up	Down	Bottom	
11.	Seoul Shoutcast	http://yp.shoutcast.com/sbin/tunein-station.	Edit	Delete	Top	Up	Down	Bottom	

Add Channel

Channel Name	URL	<input type="button" value="Submit"/>	<input type="button" value="Reset"/>
<input type="text"/>	<input type="text"/>		

- You can also add the radio channel if you know the published audio stream URL with the streaming format as follow:
1. Transport: HTTP progressive like HLS and HTTP like Shoutcast, Icecast
 2. Audio: MP3, AAC, AAC+
 3. Playlist: M3U, PLS

16. Trouble Shooting

Problem	Cause	Solutions
Cannot connect to Wi-Fi network	Network down	<ul style="list-style-type: none"> • Confirm that a Wi-Fi or Ethernet Wired connected PC can access the internet (i.e. can browse the web) using the same network. • Check that a DHCP server is available, or that you have configured a static IP address on the radio. • Check that you firewall is not blocking any outgoing ports. As a minimum the radio needs access to UDP and TCP ports 80,443 and 8008, DNS port 53.
	Router restricts access to listed MAC addresses	Obtain the MAC address from Configuration > Information > Network > Wi-Fi MAC and add to the allowed equipment list on your access point. Note: The radio has separate MAC addresses for wired and wireless networks
	Insufficient Wi-Fi signal strength	<ul style="list-style-type: none"> • Check distance to router; see if a computer can connect to the network in this location • Optimize the distance of the router's location
	Unknown encryption method	Change encryption method on router. The radio supports WEP, WPA, WPA2
	Firewall preventing access	Windows Media Player: varies — non Microsoft firewalls may require configuration for UPnP.

16. Trouble Shooting

Problem	Cause	Solutions
<p>If your radio can connect to the network successfully, but is unable to play particular stations</p>		<ul style="list-style-type: none"> • The station is not broadcasting at this time of the day (remember it may be located in a different time zone). • The station has too many people trying to attach to the radio station server and the server capacity is not large enough. • The station has reached the maximum allowed number of simultaneous listeners. • The link on the radio is out of date. The update of the link is done regularly. To get the updated list of stations, please access from Internet radio > Skytune. If case a particular stream is still not working, please contact us or Skytune to report the case.
<p>No DAB/FM reception</p>		<ul style="list-style-type: none"> • Please carry out “Reset to default” on the radio and extend the antenna. • Move the radio close to the window.
<p>DAB/FM Radio reception is poor</p>		<ul style="list-style-type: none"> • Please check that the aerial is extended for the maximum signal strength and adjust the direction to improve reception. • Check that you do not have other electrical equipment too close to your radio, causing interference.
<p>No sound</p>		<ul style="list-style-type: none"> • Please check if the volume is muted. Tune up the volume and see. • If that happens on a particular internet radio station, please try other channels and see if this is isolated issue on that station.

Helpful Tips

1. If the Internet Radio keeps re-buffering radio station:

The Internet Radio is streaming the data from the radio station via your broadband connection, if there is a high error rate on your broadband connection, or the connection is intermittent, then it will cause the Internet Radio to pause until the connection is re-established and it has received enough data to start playing again. If your Internet Radio keeps stopping, please check the DSL modem to ensure that the Broadband line is not suffering a high error rate or disconnections. If you are experiencing these problems, you will need to contact your broadband supplier.

2. What is Buffering?

When playing a stream, the Internet Radio/Media player, downloads a small amount of the stream before it starts playing. This is used to fill in any gaps in the stream that may occur if the internet or the wireless network is busy. The Internet Radio streams music data from the PC while you are listening. If a stream gets blocked or experiences Internet congestion while transferring it may stop/interfere with the quality of play. If this happens, check your internet connection speed- it must be faster than the speed of the streams.

3. My Radio is working but some stations cannot be played.

The problem may be due to one or more of the followings:

- a. The radio station is no longer broadcasting.
- b. The radio station has reached the maximum allowed number of simultaneous listeners.
- c. The radio station has changed the stream arrangement and the link is no longer valid.
- d. The radio station is not broadcasting at the time of the day (not all stations are broadcasting 24 hours throughout the day).
- e. The Internet connection between your Radio and the radio station server is too slow or unstable to support the data rate of the broadcast.

Technical Specification

Model	WR-860
Power input	9V  2A
Power voltage	100-240V~50/60Hz
Wireless Network	IEEE802.11b/g/n
Wireless network frequency	2412 - 2484 MHz
Security Protocol	WEP/WPA/WPA2
Bluetooth version	V4.2 BR/EDR compliant
Bluetooth frequency	2.4 GHz
Bluetooth range	10 meters (line of sight)
DAB frequency range	174.928MHz (5A) - 239.200MHz (13F) Support DAB and DAB+
FM frequency range	87.5-108MHz
Audio input	3.5 mm Aux-in jack USB port for playback Micro SD slot
Audio output	Stereo earphone jack 3.5 mm 3.5mm line out jack
Telescopic antenna	
Unit Dimension	310 x 133 x 185mm(L x H x D)

Remark: Specification may vary without notice

In the box

- Internet Radio
- Power adaptor
- Remote control (without batteries)
- User manual

WEEE and Recycling



The European laws do not allow any more the disposal of old or defective electric or electronic devices with the household waste. Return your product to a municipal collection point for recycling to dispose of it. This system is financed by the industry and ensures environmentally responsible disposal and the recycling of valuable raw materials.

FCC

This equipment has been tested and found to comply with the limits for a Class B digital device, pursuant to part 15 of the FCC Rules. These limits are designed to provide reasonable protection against harmful interference in a residential installation. This equipment generates, uses and can radiate radio frequency energy and, if not installed and used in accordance with the instructions, may cause harmful interference to radio communications. However, there is no guarantee that interference will not occur in a particular installation. If this equipment does cause harmful interference to radio or television reception, which can be determined by turning the equipment off and on, the user is encouraged to try to correct the interference by one or more of the following measures:

- Reorient or relocate the receiving antenna.
- Increase the separation between the equipment and receiver.
- Connect the equipment into an outlet on a circuit different from that to which the receiver is connected.
- Consult the dealer or an experienced radio/TV technician for help.

Caution: Any changes or modifications to this device not explicitly approved by manufacturer could void your authority to operate this equipment.

This device complies with part 15 of the FCC Rules. Operation is subject to the following two conditions: (1) This device may not cause harmful interference, and (2) this device must accept any interference received, including interference that may cause undesired operation.

This equipment complies with the FCC RF radiation exposure limits set forth for an uncontrolled environment. This equipment should be installed and operated with a minimum distance of 20cm between the radiator and any part of your body.