

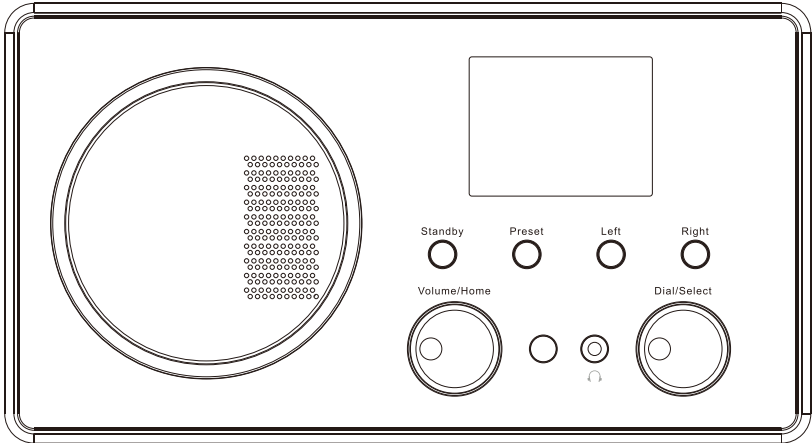

Wooden Internet Radio with DAB

WR-282CD

User Manual



Please read this user manual carefully before using the receiver

Location of Controls	1
Remote Control	2
Getting started	4
Connecting to your WiFi network	5
Internet Radio	6
Spotify Connect	8
Media Center	8
FM mode	9
DAB Mode	10
Information Center	12
Aux In	12
DLNA	12
Configuration	13
Trouble Shooting	19
Technical Specification	21

Location of Controls

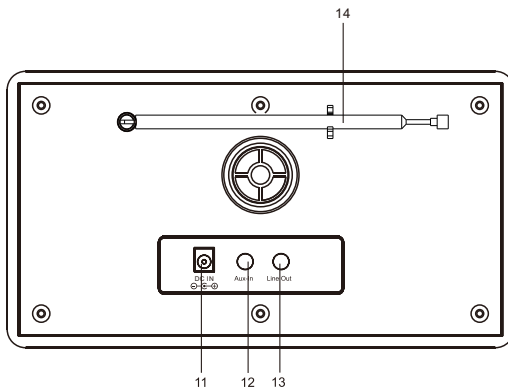
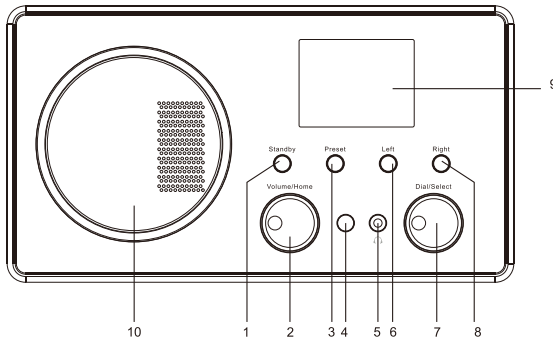

1. Standby button

2. Volume/Home

Rotate to adjust the volume level/Press the knob to return Home (main menu).

3. Preset

Long press to enter the "Add to favourite" list. Press it briefly to recall the preset list.

4. Infrared remote sensor

5. 3.5 mm earphone jack

6. Left

Left cursor/Press to return to previous menu.

7. Dial/Select

Rotate to browse the menu/Press to confirm a selection or stop the playback.

8. Right

Right cursor/View radio info

9. 2.4" color display

10. Speaker

11. DC IN Socket

12. Aux-In Jack

13. Line out Jack

14. Telescopic antenna

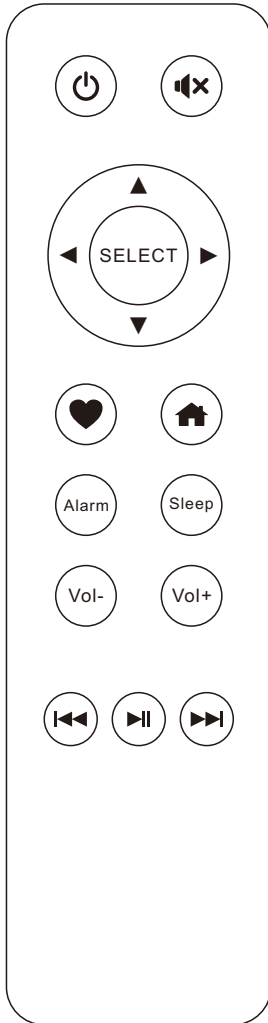

1. : Standby button
2. : Mute
3. : Cursor up
4. : Cursor down
5. : Cursor left / back to previous menu
6. : Cursor right
7. **SELECT**: confirm button
8. : Favorite button, press to recall the favorite stations, hold to enter the "Add to favourite" list
9. : Main menu
10. **Alarm**: Alarm button, press to set the alarm
11. **Sleep**: Sleep Timer, press to set the sleep time
12. **Vol+**: Volume up
13. **Vol-**: Volume down
14. : Previous radio channel on the list / previous song on UPnP
15. : Play/pause (for UPnP)
16. : Next radio channel on the list / next song on UPnP

Before you start

Please ensure the following is ready:

- You have a broadband internet connection.
- A wireless (Wi-Fi) broadband router is connected to the internet successfully. The radio supports Wireless B, G and N connection (Wireless N router can also be used with the setting on B or G).
- You know the Wired Equivalent Privacy (WEP) or Wi-Fi Protected Access (WPA) data encryption code/password. You need to key in the correct code when the radio is connected to the wireless router for network connection. If you do not know the code/password, please contact the person /technician who set up the router/network for you.
- The radio can work via Wireless network connection (Wi-Fi connection).

Precautions

- The radio should not be used in a high temperature or high humidity environment over prolonged periods of time as this may damage the unit.
 - Keep the radio away from liquids as it may get damaged. Please switch off the radio immediately if water or liquids is spilled into the radio. Consult with the shop you bought this radio for any question.
 - Avoid using or storing the unit in dusty or sandy environment.
 - Do not open and repair the radio by yourself.
 - Use only the DC adaptor supplied with the radio.
- Connecting a power supply with a different rating will cause permanent damage to the radio and may be hazardous.
- Clean only with dry cloth

WARNING: TO PREVENT FIRE OR ELECTRIC SHOCK HAZARD,
DO NOT EXPOSE THIS PRODUCT TO RAIN OR MOISTURE.

CAUTION

**RISK OF ELECTRIC SHOCK
DO NOT OPEN**

CAUTION: TO REDUCE THE RISK OF ELECTRIC SHOCK, DO NOT REMOVE THE RADIO BACK. NO USER SERVICEABLE PARTS INSIDE. REFER SERVICING TO QUALIFIED SERVICE PERSONNEL.



THE LIGHTNING FLASH AND ARROWHEAD WITHIN THE TRIANGLE IS A WARNING SIGN ALERTING YOU OF "DANGEROUS VOLTAGE" INSIDE THE RADIO.



THE EXCLAMATION POINT WITHIN THE TRIANGLE IS A WARNING SIGN ALERTING YOU OF IMPORTANT INSTRUCTIONS ACCOMPANYING THIS RADIO.

Connect the mains adaptor to the radio unit, one end to the DC IN on the radio and the other end to the mains wall outlet.

Caution: Use only the mains adaptor supplied with the radio. Connecting a power supply with a different rating will cause permanent damage to the radio and may be hazardous.

The display on the front of the radio will light up and show:



Then you can select your prefer language on the radio.

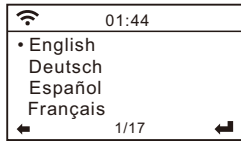

It will ask you if you want to Enable the **<Check Network when Power on>**, it is suggested to choose **<Yes>**. Then the radio will always check the available WiFi network automatically.

Connecting to your WiFi network

The screen below will appear. You can choose **<Yes>** to proceed to search for the available WiFi network. If your router has the WPS function, you can select **<Yes(WPS)>** to proceed.

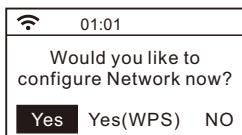

It will then start scanning the network. After the search is done, it will display a list of the available router.

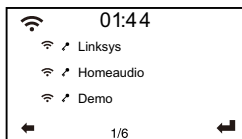

Choose your router from the list, enter the WEP(Wired Equivalent Privacy) or WPA(Wi-Fi Protected Access) code. If your network is not enabled with security code, the unit will connect to the router automatically.

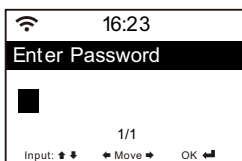

Note: The encryption code would have been set up by the person who set up and configured your network.

Please follow the steps below to enter the encryption code of your router using the buttons on the radio:

- Rotate the **<Dial/Select>** knob to browse the character
- Press the **right** button to skip to the next entry
- After you finish with the entries, press the **<Dial/Select>** knob to confirm. Do **NOT** press the right button again.

To use the remote control entering the password: Press "**▲**" or "**▼**" button to select the characters. Press the "**▶**" button for the next entry, press "**◀**" button to delete the character or to amend it. When the last character is entered, press the **<SELECT>** button this time. Do **NOT** press the "**▶**" button.

The radio will start connecting to the network.

After the router is connected successfully, it will display the main menu as follow:

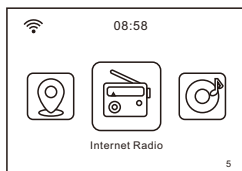

You can now start enjoying the internet radio.

Choose **<Internet Radio>** from the menu, you can see several listed options. To start listening the radio stations worldwide, select **<Radio Station/Music>**.

My Favorite

This is to show the list of your Favorite stations which have been assigned to the presets.

To preset a station:

While you are playing the favorite station, long pressing the **<Preset>** button (♥ on the remote) and the **<Add to My Favorite>** menu will display. Press the rotary knob to confirm. The playing station will be added to the preset list automatically.

Press **[Dial/Select]** knob to confirm

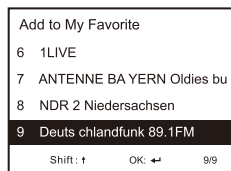

The symbol  means the station has already been added to the favourite list

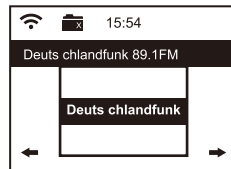

The presets will be stored in ascending order. You can store up to 250 presets.

Note: Preset 1 to 5 are reserved for your own choice of the dedicated radio channels. Scroll to choose the desired number to save your favourite channel. To save more channels after the first five presets are occupied, press and hold the preset button and it will assign to preset no. 6 onwards.

You can edit your favorite list anytime. Go to **Internet radio> My Favourite** or press the **<Preset>** button (♥ on the remote), When it displays the list of favorite stations then press the right button. The following options will display:

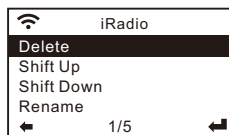

Delete – To delete the selected station

Shift up- To shift the selected station by one level up on the ranking

Shift down – To shift the selected station by one level down on the ranking

Rename – To rename the selected station

Play – press and play the selected station

Choose the radio station that you want to make with the above changes. Then press the **Right** key, it will enter into the list with the options listed above. Then choose your desire action.

Internet Radio

To recall a preset station:

Press the <Preset> button (♥ on the remote) briefly and choose your desired station.

Radio Station / Music

Select this option, then you can select your desired radio station by Category, Genre or Location., etc.

Local Radio

If you want to access quickly the radio station located in your area via internet, , select this function and it will display the list of the stations available.

History

The radio will memorize the last listened 10 stations.

Service

Search Stations

You can find your desired radio station by entering the name of the radio.

Add New Radio Station

If you cannot find your desired station from the Radio station list and you have the URL address, you can input the link here and add to your favorite list.

Note: The URL has to be an audio streaming URL in order to play on the radio.

When the radio station is playing, the display will show a color image transmitted from the radio station.



Spotify Connect

A better way to listen at home. Listen on the WR-282CD using the Spotify app as a remote. Enjoy the music together.

Use your phone, tablet or computer as a remote control for Spotify. Go to spotify.com/connect to learn how.

The Spotify Software is subject to third party licenses found here: www.spotify.com/connect/third-party-licenses



Please make sure your device is on the same Wi-Fi network as the Radio before you start using this function.

Media Center

UPnP (Universal Plug and Play)

The device supports UPnP and is DLNA-compatible.

This provides the opportunity to stream music from your other network devices. However, this requires you to have a compatible device in your network that can function as a server. This can be e.g., a network hard drive or a conventional PC with e.g., Windows 8 via which access to the shared folder or media sharing is permitted. The folders can then be browsed and played on the Tuner.



Please make sure your computer laptop is on the same Wi-Fi network as the Radio before you start using this function.

Music streaming

1. Once the UPnP/DLNA compatible server is configured to share media files with your radio, you can start music streaming.
 2. On the main menu, select **[Media Centre]** and choose **[UPnP]**.
 3. It may take a few seconds for the radio to complete the scan for available UPnP servers. If no UPnP servers are found, it will show **[Empty List]**.
 4. After a successful scan is done, select your UPnP server.
 5. The radio will show the media categories available from the UPnP server, e.g. 'Music', 'Playlists' etc.
 6. Choose the media files that you wish to play.
- You can set the mode of playback under **Configuration>Playback setup**.

My Playlist

You can make your own playlist from the UPnP music files. Choose and highlight the song you want to add to playlist, press and hold the **[Dial/Select]** knob, until the sign appears. The song will be added to **My playlist**.

Clear My Playlist

Remove all songs in **My playlist** to allow a new playlist to be prepared.

Note - If you have DLNA compatible servers available, follow the steps described above to browse the audio files from DLNA compatible device on the radio to play.

FM mode

You can listen to the ordinary FM radios without internet connection.

Extend the telescopic antenna or in other direction / length of the antenna may be required to optimize the reception level.

Choose the FM from the main menu or use the <  > button on the remote to find to FM mode.

To auto scan the next available FM station, press and hold the <Left> or <Right> button for 2 seconds, the radio will seek the next available station. If you want to fine tune the frequency, rotate the <Dial/Select> knob on the unit or press the ▲ / ▼ button on the remote control.

Auto preset scan

There is an option to auto preset the FM station. Press the <Dial/Select> knob (or **Select** button on the remote), it will ask you whether to Auto Scan or not. Choose "Yes" and press <Select> to confirm, and it will start scanning and preset the station. When it is finished, press the <Preset> button ( on the remote) and it will display the first preset station.

The preset can be superseded by a new station anytime.

Service Following

This is a feature to help finding the same channel over internet provided that the radio station has an internet stream available and it is suitable to play on the radio. Listening over internet radio allows free of noises which usually caused by interference or weak reception over FM.

After the scan is done on FM, choose a channel to play. If the same channel is available on Internet, there will be an icon appeared as follow:



Press and hold the <Dial/Select> knob (or <Select> button on remote), it will switch to the internet radio mode to play the corresponding channel.

It can store up to 99 presets.

You can listen to ordinary DAB channels without internet connection.

Extend the telescopic antenna or in other direction / length of the antenna may be required to optimize the reception level.

Choose the DAB from the main menu or use the <  > button on the remote to find to DAB.

If this is the first time you use the DAB mode, it will scan the DAB radio station automatically. It will display the DAB station list when the scan is done.

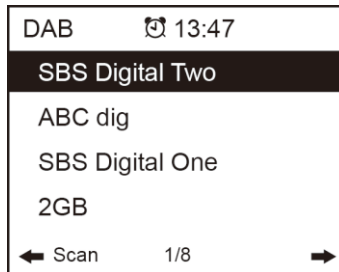

Choose the station you want to listen, and press the <Dial/Select> button (or **Select** button on remote) to confirm for playing. Press the <Left> button (or ◀ on remote) to return to station list. If you press the <Left> button (or ◀ on remote) again, it will display as follow. It allows for a re-scan of the DAB stations:

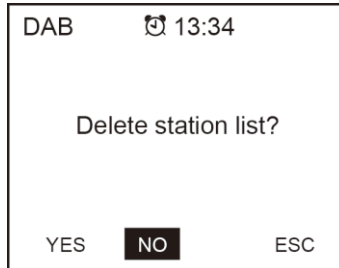

Choose <NO> to keep the existing station list and scan for any new stations.

Choose <YES> to delete the existing station list and perform a full scan again.

Choose <ESC> to exit the current operation.

To stop playing the station, press the <Dial/Select> knob (or **Select** button on remote). Whenever you want to resume to play, press the same button again.

DAB Mode

Service Following

This is a feature to help finding the same channel over internet provided that the radio station has an internet stream available and it is suitable to play on the radio. Listening over internet radio allows free of noises which usually caused by interference or weak reception over DAB.

After the scan is done on DAB, choose a channel to play. If the same channel is available on Internet, there will be an icon appeared as follow:



Press and hold the **<Dial/Select>** knob (or **<Select>** button on remote), it will switch to the internet radio mode to play the corresponding channel.

It can store up to 99 presets.

Information Center

Weather

The radio provides weather information and can display in Standby mode. To enable this feature, follow the steps below:

Go to main menu, choose **Information Center> Weather Information**, choose the region you want it to display the weather information. After region is selected, press the **<Dial/Select>** knob (or **Select** button on remote) it will display the weather info of the selected region. Then press the same button again and it shows **<Add to Standby Display>**, select to confirm using the **<Dial/Select>** knob or **Select** button on remote. The weather info is enabled now to display in standby. The date/time and weather info will appear alternatively every 10 seconds.

In standby with the analogue clock display, press the **right button** (or the **▶** button on remote) to see the real time weather information. Press the same button repeatedly to see the forecast for the next 4 days. To view more details for a particular day individually, rotate the **<Dial/Select>** knob to scroll down for more information (or the **▲ / ▼** button on the remote). To refresh the weather information, press the **<Dial/Select>** knob or **Select** button on the remote.

Remark: The weather is just for reference only. It may have deviation to the actual weather.

System Information

You can view the information of the radio such as the Version of the software / Wlan Mac / IP address..etc.

Aux In

You can enjoy the music from other audio devices by connecting the audio cable to the AUX IN connector at the rear of the unit, such as mobile phone, MP3 player, etc.

DLNA

The Internet radio can play music stream from DLNA compatible device, provided that the Internet radio and other DLNA devices are under the same Wi-Fi network.

The radio will be discovered as “AirMusic” when you try to search it on other devices. If you want to change other name from AirMusic, go to Configuration and DLNA setup to make the change.

Configuration

Time Display

You can choose the time display at Analog or Digital.

Manage my mediaU

You can tailor made your own favorite station list using your computer.

- 1) Go to <http://www.mediayou.net/> and sign up to become a member.
- 2) Then you have to find out the Mac Address to register on the Media U website.
To locate the MAC address, please follow the path below:
 - 2a) Go to Main Menu and select **<Information Center>**
 - 2b) Go to **<System Information>**
 - 2c) Choose **<Wireless Info>** and you will find your Mac address.
- 3) Log-in Media U on your computer, click **My Media U > Radio**, then input the Radio name and Serial number (i.e. MAC Address) and save it.

The screenshot displays the Media U website interface. At the top, there is a logo for 'media U' and a search bar with the text 'Search station, genre / location / city / callsign...'. Below the search bar are buttons for 'Genre', 'Location', and 'DAB'. The main navigation menu includes 'Home', 'my mediaU', 'Manage', and 'Radio'. The 'Radio' tab is selected, showing a section titled 'my mediaU radio'. Below this, there is a blue banner with instructions: 'By registering your radio that support 'my mediaU' function, You can : 1. Organize favorite stations for your radios. 2. Manually add stations on your radios.' A link 'Add radio (PC and mobile phone users not required)' is provided. The form contains two input fields: 'Radio Name' with the placeholder 'Name your radio here.' and 'Serial Number' with the placeholder 'Enter radio's access code here.' and a link 'Where and how to get serial number:'. A 'Save' button is located at the bottom of the form.

You can then organize your own favorite stations or add any new station which is currently not found on the station list. Once the changes are done, your radio will synchronize the changes immediately and you will find your favorite list under **<My MediaU>** on the radio menu.

media U

Hello Caleb my mediaU Edit profile Logout

Search station, genre / location / city / callsign... Search

Genre Location DAB

Home my mediaU Manage Radio

my mediaU + Manually Add a Station

Favorite Station

Station

Favorite Location/Genre

Not Set

Local Station (City)

Not Set

Manually Add

Not Set

Add some new Radio Stations to my mediaU.

Note: If you are going to add URL which is not on Media U database, ensure the URL is an audio streaming URL or contact Media U to add it for you.

media U

Hello Caleb my mediaU Edit profile Logout

Search station, genre / location / city / callsign... Search

Genre Location DAB

Home my mediaU Manage Radio

my mediaU > Manually Add a Station

* Station Name Set the station Name here

* Folder Not Set Add a new folder

* Url >>Add your personal URLs right here<<

Enter AOD file or Radio URL.
Type : WMA, MP3 (http://, mms:// ...)

Related Information (Station)

Location Hong Kong

Genre

Website

Note

Configuration

It allows maximum 5 users to register with the same radio and you can switch to listen the favorite list under one user at a time

To find your added station / custom favorite list on the radio, go to **Configuration > Manage my mediaU > Enable**
Then go to main menu and choose **<My Media U>**.

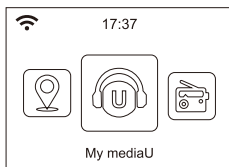

You will find listed options with your favorite list.

Important: Whenever any update is done on your **<My Media U>** account, you have to disable the My Media U and enable it again to refresh and get the latest updated list. (**Configuration> Manage my mediaU > Disable>Enable**)

Network

Wireless Network Configuration

Press the **<Dial/Select>** knob (or **Select** button on remote) to scan the available wireless network.

Wireless Network (WPS PBC)

The WPS allows to connect the radio with your router by pressing one key on the radio and a WPS key on your router for wifi connection, provided that your router has the WPS function.

Manual Configuration

You can set the DHCP on or off, and enter the SSID name, or delete the connected SSID.

Check network when power on

This is set to enable or disable **<Check network when power on>**.

Date & Time

The time is set automatically to your local area.
You can choose to manual set the time if you want.

Time Format setting

Time format setting: 12hours / 24hours

Date Format setting

Date format: YYYY/MM/DD, DD/MM/YYYY and MM/DD/YYYY

If manual setup is selected, you will see an added item **Daylight Saving Time (DST)** setting appeared on the list.

Alarm

Dual alarm clock

There are 2 alarm clocks available and settings as follow:

Scheduling alarm: You can schedule the alarm repeated for every day, particular day in the week or just once.

Alarm sound: Wake to Radio (must be the preset station), Wake to Melody and Wake to Beeping sound.

Alarm Volume: select this option to adjust your desire volume level.

NAP Alarm

If you would like to take a nap or need an alarm to due in short time, you can use this function.

You can select the time from 5 minutes up to 120 minutes. No Snooze function available for the NAP alarm.

Remark: The NAP Alarm will only release beeping sound.

Snooze

When the Alarm sounds, press any key except **<Standby>** button will enter into **<Snooze>** mode. The alarm will come on again 5 minutes later. You can always press **<Standby>** button to cancel the alarm.

Remark: In case there is network issue renders the wake to radio not working, it will auto release beeping sound after 1 minute.

Language

There are 17 Languages available, such as English, German, French, Norwegian, Italiano, Svenska, Dansk and others.

Dimmer

You can adjust the backlight of the LCD with below settings:

Power Saving

You can set the backlight to dim down when there is no operation for a certain time of period.

Turn on

You can adjust the backlight level for the operation mode, i.e. when you are operating the radio or checking on the menu.

Display

You can choose the display in color or monochrome style.

Power Management

This function is to allow the radio to go to Standby if there is no internet signal received in order to save power. The default setting is 30 minutes. When the radio does not receive any internet signal, the radio will go into Standby after 30 minutes. Other time frame for 5 minutes and 15 minutes are available. You can choose to turn it off too.

Configuration

Sleep Timer

You can set the timer to put the radio in standby after certain time elapsed, from 15 minutes to 180 minutes with the step of every 15 minute.

You can also do the setting with the **<Sleep>** button from remote control, when you press **<Sleep>**, then you can see the sleep timer on the top right corner of the display.

Buffer

Sometimes you may experience uneven playback of the internet radio. This can happen if the internet connection is slow or network congestion occurs. To help improving the situation, you can choose longer buffer time to get a few seconds of radio stream before beginning to play. The default value is 2 seconds. You can choose 4 or 8 seconds if you prefer to have a longer buffering time.

Weather

You can set to display the weather information in standby mode by choosing different regions and the temperature unit. To turn off the weather display, please navigate to Configuration > Weather > Show on Standby > select OFF

Local Radio Setup

The radio will detect your local area stations automatically and simply press the **<Local>** on the radio to access the radio stations in your local area. You can find it under the **<Internet radio>** menu too.

If you would like to change the Local area stations to other countries, you can choose "Manual setup" to make the change.

Playback Setup

This is to set the preference of UPnP playback. You can set the playback as Off, Repeat one, Repeat all, Shuffle.

Device

DLNA Setup

The radio can play music from DLNA compatible devices which connected to the same wifi network as the radio. The radio will be discovered by the DLNA devices with the name as "AirMusic". This is the name by default. You can change other name here as you desire.

Remark: The DLNA feature is compatible and works with corresponding 3rd party Apps on Android platform. Apple devices are not supported.

Remote App - AirMusic Control

Using your smart phone / tablet to control the radio by installing the App "AirMusic Control".

It is available on Android Play store and iOS App Store. It's free of charge.

Both the radio and the device with the remote app installed must be on the same wifi network to work.

Search the App with the name "AirMusic Control" 

You can also locate it by scanning the QR code below:

Android:

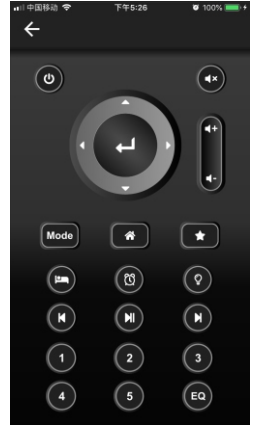
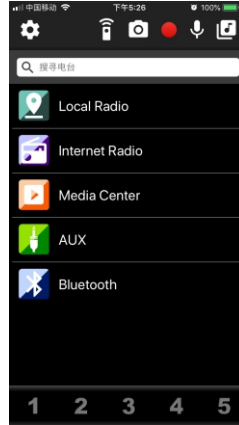
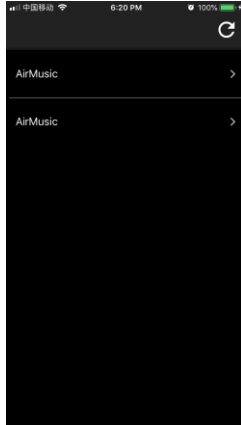

iOS:



Equalizer

Select your prefer equalizer to suit your listening preference.

Resume When Power On

The radio will resume playing the last listened station when you power it on next time if ON is selected in this option. The ON is set by default.

Software update

Upgrade information will pop up on the display when there is update version available.

Note: This option is for manufacturer's use only.

Reset to default

You can do this factory reset to empty all of the settings and it comes back to default settings.

*****Please note all the Station presets, Settings and configuration will be lost after you have carried out the "Reset to default".***

1. If you have trouble connecting the radio to your wireless network, these steps may help to resolve the problem:

- Confirm that a Wi-Fi or Ethernet Wired connected PC can access the internet (i.e. can browse the web) using the same network.
- Check that a DHCP server is available, or that you have configured a static IP address on the radio.
- Check that you firewall is not blocking any outgoing ports.
- Some access points may be set so that only equipment with registered MAC addresses can connect to them. This is one possible cause of the Internet Radio being unable to connect to the Wi-Fi network, and the Internet Radio display will show Bad ESSID or key. To overcome this problem you will need to add the Internet Radio's MAC address to the list of allowed equipment in your access point. The Internet Radio's MAC address can be found using the menu **Information Center > System Information > Wireless Info > MAC address**. You will need to refer to the guide for you Access Point in order to enter the Internet Radio as an allowed piece of equipment.
- If you have an encrypted network, check that you have entered the correct key or passphrase into the radio. Remember that text-format keys are case sensitive.
- If your wireless network name(ESSID) is 'Hidden'(a setting on the wireless access point), then you can either turn on the name, or you can manually enter the name into the internet radio and media player, Select **<Configure -> Network -> Manual Configuration-> Wireless -> Enter ESSID>**. Confirm if the Network is encrypted, e.g. requires a WEP or WPA key, then enter the network name.

2. If your radio can connect to the network successfully, but is unable to play particular stations, it may be due to one of the following reasons:

- The station is not broadcasting at this time of the day (remember it may be located in a different time zone).
- The station has too many people trying to attach to the radio station server and the server capacity is not large enough.
- The station has reached the maximum allowed number of simultaneous listeners.
- The station is not broadcasting anymore.
- The link on the radio is out of date. This is updated automatically every day, so the next time you turn on the link will be recognised. In case it is still not updated, please contact MediaU for the update <http://www.mediayou.net/web/index.php>
- The internet connection between the server (often located in a different country) and yours is slow. Some internet service providers may fail to stream in certain geographical areas. Try using a PC to play back the stream via the broadcaster's web site. If you can play back the station with a PC, please report to the customer service where you bought this radio. If you have a laptop, try connecting it if your Internet Radio cannot find the station.

3. When you scan for PCs under UPnP function, none can be found, or the PC you are looking for does not appear in the list:

- You have not connected to the wireless Access point. On the internet radio, select 'Configuration', 'Network', 'Wireless network connection' and then select your Wireless network. (You may need to enter a security key to access the network wirelessly).
- You have a firewall set on your PC which is stopping you accessing shared files.
- If you have a third party firewall (Like Norton, or Zone Alarm) that will have its own control panel and you will need to consult the manual for your firewall.
- If your PC is connected to a managed network, with a server sometimes the PC being searched for needs to be set to Home group. See the instructions under Media Center.

4. You can see the PC you want to play music from, but cannot find any folders on the PC:

- You have a firewall running which is preventing the internet radio from seeing the shared folder. As a quick check, you can disable firewalls like Norton to see if this overcomes the problem, if this resolves the issue then you can either leave the firewall off, or allow file sharing through the fire wall.

Note: If you firewall is required to provide security for your system, it should not be left off.

5. If the Internet Radio keeps re-buffering radio station:

- The Internet Radio is streaming the data from the radio station via your broadband connection, if there is a high error rate on your broadband connection, or the connection is intermittent, then it will cause the Internet Radio to pause until the connection is re-established and it has received enough data to start playing again.
- If your Internet Radio keeps stopping, please check the DSL modem to ensure that the Broadband line is not suffering a high error rate or disconnections. If you are experiencing these problems, you will need to contact your broadband supplier.

6. What is Buffering?

When playing a stream, the Internet Radio/Media player, downloads a small amount of the stream before it starts playing. This is used to fill in any gaps in the stream that may occur if the internet or the wireless network is busy. If a stream gets blocked or experiences Internet congestion while transferring it may stop/interfere with the quality of play. If this happens, check your internet connection speed- it must be faster than the speed of the streams.

Technical Specification

Model	WR-282CD
Power input	5V \equiv 1A
Power voltage	100-240V~50/60Hz
Wireless Network	IEEE802.11b/g/n
Security Protocol	WEP/WPA/WPA2
FM frequency range	87.5-108MHz
DAB frequency range	174.928MHz (5A) - 239.200MHz (13F) support DAB and DAB+
Audio output power	3W (RMS) x 1
Audio sockets	3.5mm earphone jack 3.5mm Aux-in jack 3.5mm Line out jack
Unit Dimension	220 x 114 x 120 mm (L x D x H)

Remark: Specification may vary without notice

What is included in the box

- * Internet Radio
- * Power adaptor
- * Remote control
- * User manual

WEEE and Recycling



The European laws do not allow any more the disposal of old or defective electric or electronic devices with the household waste. Return your product to a municipal collection point for recycling to dispose of it. This system is financed by the industry and the ensures environmentally responsible disposal and the recycling of valuable raw materials.

Ocean Digital Technology Ltd.
Flat B, 12/F., Yeung Yiu Chung (No.8) Ind. Bldg.,
20 Wang Hoi Road, Kowloon Bay,
Hong Kong
Email: support@oceandigital.com.hk