

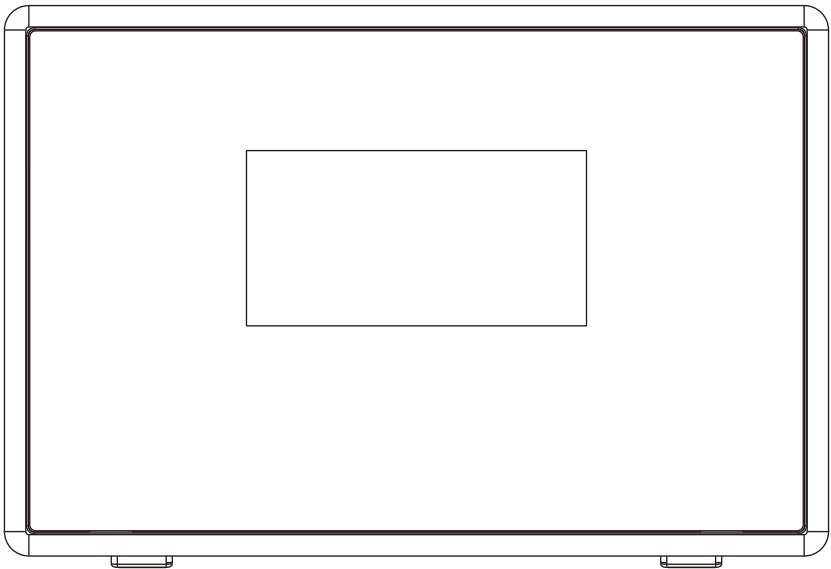

USER MANUAL

Stereo DAB Radio with Color Display



Model no: DB-825C

Please read this user manual carefully before using the receiver

Location of Controls

Top

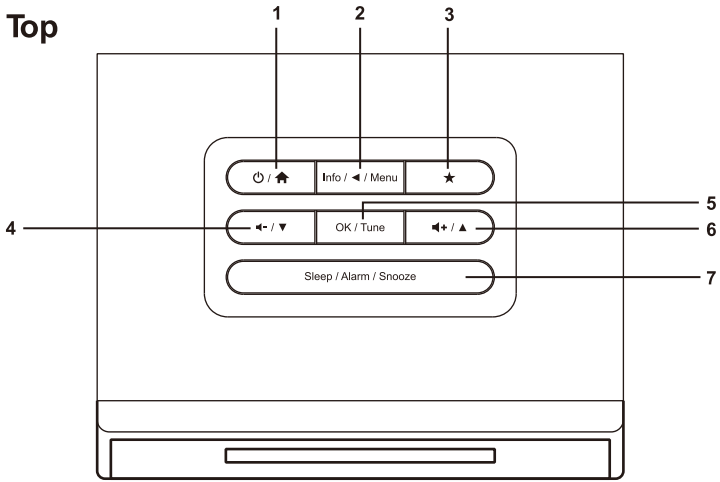



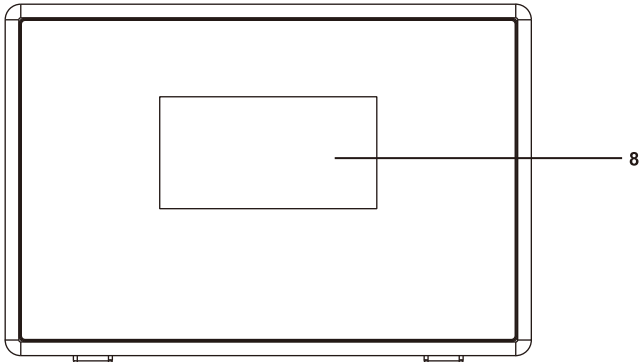



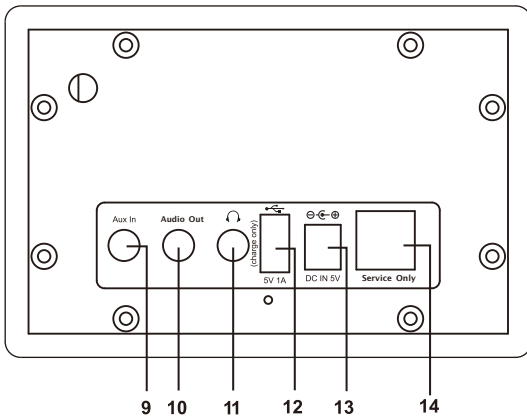

Front



Back



1.  / 
 - Long press the button to turn the radio to Standby.
 - Press the button once to turn the radio on from Standby.
 - To return main menu for mode selection when the radio station is playing, press this button once.
2. **Info /  / Menu**
 - Long press the button to enter the main menu.
 - Under the radio playing screen, press the button repeatedly to cycle through the information broadcasted by the radio station.
 - To exit a menu, press the button return to previous state.
3. **★**
 - Preset button.
 - Press and hold the button to enter into the Preset Store list.
 - Press the button once to recall the preset list.
4.  / 
 - Volume down/Scroll down button.
 - To decrease the volume level, press the button under the radio playing screen to adjust the volume.
 - Long pressing under the playing screen will enter into the radio station list.
 - On any menu list, press the button to scroll down on the list.
5. **OK/Tune**
 - Press the button when you want to confirm a selection.
 - Under DAB mode:
 - *Press to enter into the station list.
 - *When it is under playing screen and there is image / slideshow released by the broadcaster, long press the button to start the slideshow. To exit, press the **Info /  / Menu** button once.
 - Under FM mode:
 - *Long press the button to auto scan the next station.
 - *Press the button once to enter the fine tune mode
6.  / 
 - Volume up / Scroll up button.
 - To increase the volume level, press the button under the radio playing screen to adjust the volume.
 - Long pressing the button under the playing screen will enter into the radio station list.
 - On any menu list, press the button to scroll up on the list.
7. **Sleep/Alarm/Snooze**
 - Press the button once to enter into sleep timer setting.
 - Long pressing the button to enter the alarm setting
 - When the alarm goes off, press the button to activate the snooze function.
8. **2.4" TFT color display**
9. **3.5 mm Aux-in**
10. **Audio out socket**
11. **3.5 mm earphone jack**
12. **USB port for charging 5V 1A OUT**
13. **DC IN 5V**
14. **USB upgrade port for service only**

Display Icons

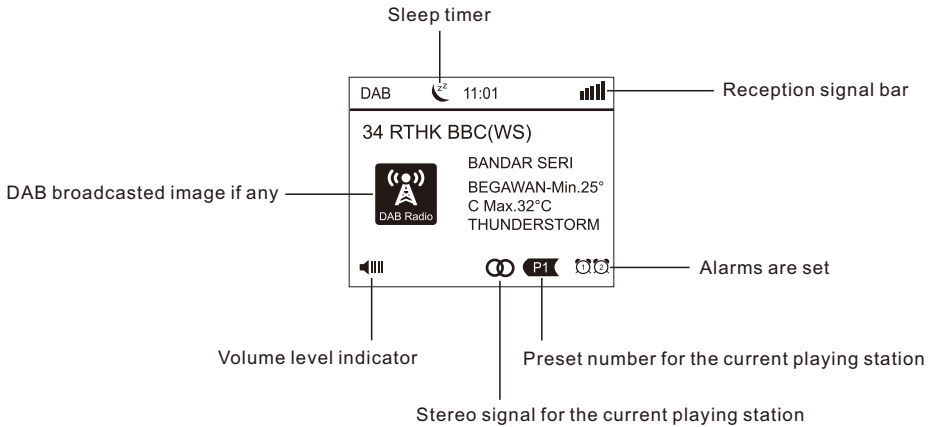

Using your radio the first time

1. Place the radio near a window if possible. Extend the wire antenna and attach it to a location as high as possible.
2. Take out the power adaptor supplied with the radio. Connect one end of the adaptor to the DC IN socket located at the rear side of the radio and the other end to the wall outlet. The radio will power on automatically.

Caution: Use only the adaptor supplied with the radio. Connecting a power supply with different rating will cause permanent damage to the radio and may be hazardous.

3. It will return to home screen with mode selection.

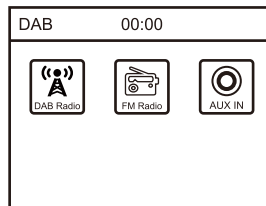

4. Choose the mode you would like to start with.
Use the ▲▼ button to choose and press <OK/Tune> to confirm.

Note:

Always make sure the wire antenna is fully extended and you may have to move the antenna around with different direction to get the maximum signal strength and the best possible sound quality.

DAB mode

Choose DAB mode on the menu, the radio will start scanning all the available radio stations as follow:

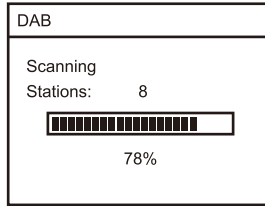

It will pop out the scanned station list. Use the ▲ ▼ button to choose and press <OK/Tune> to confirm the selection.

When a radio station is playing and you want to choose other stations to play, either long pressing the ▲ ▼ button or press the <OK/Tune> button once to enter into the station list.

DAB Slideshow

The radio receives images transmitted by the radio broadcaster if any.

To enlarge the images to full screen size, long pressing the <OK/Tune> button under the normal playing screen. If there are several images received, it will display in the mode of slideshow.

Press the <Info / ◀ / Menu> button once to exit.

FM mode

Select the FM mode, press and hold the <OK/Tune> to seek the next available station.

To fine tune the frequency, press <OK/Tune> button once and then press the ▲ ▼ button to tune the frequency in the step of 0.05MHz.

Aux-In mode

You can listen to the music stored in other audio device or smart phone on the radio, through the connection to the 3.5 mm aux-in jack on the rear side. Use the cable with both ends in 3.5 mm pin, one end to the aux-in jack on the radio, the other end to the earphone jack on the audio device or if it has line out socket.

Volume control

Adjust the volume level under the radio playing screen, press the ◀- / ▼ ▶+ / ▲ button to adjust.

Preset a station

Your radio can store up to 10 DAB stations and 10 FM stations in its preset memories for instant access to your favorite stations.

1. Tune your radio to the station that you wish to preset.
2. Press and hold ★ button on the radio, it will pop up the preset store list. Select the preset number you want to save by using ▲ ▼ button, press the <OK/Tune> button to confirm. It will show the preset number on the playing screen after it is saved.

Recall a station preset

Press the ★ button on the unit, the preset list will pop up. Use ▲▼ button to select the station you want to listen, then press <OK/Tune> to confirm.

Note

1. If there is already an existing DAB or FM station stored under a preset, it will be overwritten when you save a new station.
2. The DAB presets will not overwrite the FM station presets.

Alarm Setting

There are 2 alarm settings on the radio.

Press and hold the <Sleep/Alarm/Snooze> button to enter the alarm setting.

It will display Alarm 1 and Alarm 2. Choose Alarm 1 and it will display the setting as follow:

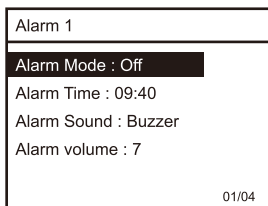

Press ▲ or ▼ to choose setting the alarm condition, then press <OK/Tune> button to enter the setting.

Alarm Mode: Press ▲ or ▼ key to choose the alarm repeating schedule, there are **Off, Daily, Once, Weekend, Weekday** for your choice, press <OK/Tune> button to confirm.

Alarm Time: Press ▲ or ▼ key to input the “Hour”, then press <OK /Tune> to confirm. Do the same to set the minute and press <OK /Tune> to confirm.

Alarm sound: Press ▲ or ▼ to choose the sound source from Buzzer/DAB/FM, then press <OK /Tune> button to confirm. If DAB and FM mode is selected, the last listened station will be used as the alarm source.

Alarm Volume: Press ▲ or ▼ to choose the alarm volume level, then press <OK /Tune> key to confirm.

Important: After all the options are set, press <Info / ◀ / Menu> button to confirm and exit the setting. Please always remember to exit the setting to confirm and the alarm clock icon will appear on the playing screen and standby screen.

Snooze

When the alarm goes off, press <Sleep/Alarm/Snooze> button and it will delay the alarm for 5 minutes.

It will come on again after 5 minutes.

To cancel the Alarm or Snooze, simply press <⊕ / ▲> button on the radio.

Main Menu of DAB mode

When you are listening to DAB radio station, press and hold the < Info / ◀ / Menu > button to enter the main menu as follow:

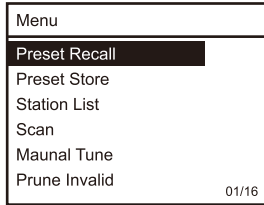

Please note if there is not any operation in 30 seconds, the radio will return to last playing mode.

Preset Recall

Preview the preset list.

Preset Store

Enter the preset store list.

Station List

Preview the DAB radio station list.

Scan

Press to scan for DAB radio stations.

Manual Tune

This function allows you to check whether a specific frequency can be received in your area and the corresponding signal strength. When this option is selected, it will show a list of DAB frequencies.

Choose a frequency and it will display a bar of signal strength. If the signal bar is empty, it means the selected frequency cannot be received in your area.

Prune Invalid

Some DAB services may stop broadcasting or you may not be able to receive a station. Prune stations will delete the DAB stations from your station list that can no longer be received.

DRC

Dynamic Range Control (also known as DRC) can make quieter sounds easier to hear when your radio is used in a noisy environment. This function is only available for the DAB.

DRC Off – No compression

DRC High – Maximum compression

DRC Low – Medium compression

Setting the compression to maximum will “boost” the quiet sounds, whilst keeping the loudest sounds at their original level.

Station Order

You can choose different station order, such as Alphanumeric, Ensemble and valid.

Equalizer

There is different equalizer available to suit your listening of the radio or music.

There are Normal, Classic, Jazz, Pop, Rock, Flat, Movie and News for selection.

Backlight

There are 3 brightness levels you can choose: High, Medium & Low.

1. Timeout: This option is used to set the period of time that you wish your display's backlight to remain lit when your radio is just playing without any operation is made.

The available options are: On /10sec /20sec /30sec /45sec /60sec /90sec /120 sec /180 sec.

Select "On" will force your radio's backlight to remain on constantly. If you select a specific time interval, after the selected time period has lapsed the display will dim down.

2. Level: This option will determine how bright the display's backlight is lit while the radio is in operation of the functions. Whenever the radio is powered up from Standby, the backlight will adjust to the brightest level.

Backlight in Standby mode

The backlight will dim to the lowest level automatically in Standby. If you want to set the dimmer level in Standby, you have to choose "On" under the "Timeout" menu first. In Standby, press the up/down button to choose the level you desire.

Time/Date

There are 3 settings:

1. Set Time/Date: This allows the user to manually set the current Time and Date.

2. Set Format: This option will change the format of your clock to either 12 hour or 24 hour format.

3. Auto Update: This function will set the radio's time and date automatically with data sent along with the broadcast of either the FM or DAB radio station. You can choose "No Update" then the radio will not receive the time data.

Note:

The FM auto Time/Date update may not work in your area, so the DAB auto update option is recommended.

The DAB auto update is set by default.

Alarm

There are two alarms can be set in the radio, please refer to the above Alarm section.

Sleep

This is the sleep timer function. The radio will turn in Standby itself when the time is due.

Press the **<Sleep/Alarm/Snooze>** button once while the radio is playing.

Use the up/down button to select the timer as you desire and press **<OK/Tune>** to confirm.

After the sleep timer is activated, you can check how much time left by pressing the **<Sleep/Alarm/Snooze>** once.

If you wish to cancel the sleep timer function, you have to enter into the main menu by long pressing the **<Info / ◀ / Menu>** and select the Sleep function. Then choose "Off" and press **<OK/Tune>** to confirm.

Factory reset

You can reset the radio to the factory default any time. Once a reset is done, all previous settings and preset will be erased and the radio will resume to the menu for mode selection.

Information

Press to see the firmware version.

Language

There are six languages available for the menu, English, Dutch, French, German, Italian and Norwegian.

The radio is default in English.

Main Menu of FM mode

While the radio is in FM mode, press and hold the **< INFO / ◀ / MENU >** button on the radio. Most of the menus are the same as DAB mode, with the additional options as follow:

Scan setting

You can choose to scan “Strong station only”.

Audio setting

You can set if you prefer “Mono only”.

Main Menu of Aux-In mode

When the radio is in Aux-In mode, press and hold the **< INFO / ◀ / MENU >** button to enter main menu.

All of the menus have the same function as the setting in DAB mode.

USB port for charging

There is a USB port on the radio for charging mobile devices at 5V 1A.

Audio output

The 3.5 mm audio output jack is to connect external powered speaker if you want to enjoy with your other speaker system.

Q & A

If you are experiencing problems with your DAB radio there are some quick and easy checks that you can do, which may help to solve the problem.

No DAB reception

- Please carry out “Factory Reset” on the radio and extend the antenna.
- Move the radio near to the window.

Radio reception is poor

- Please check that the wire antenna is extended for the maximum signal strength and move it around in different direction to improve the reception.
- Use the manual tune to check if the specific frequency reception level.
- Check that you do not have other electrical equipment too close to your radio, causing interference.

Cannot tune other radio station

- Under DAB mode, press the **<OK/Tune>** button first to enter the station list. Then use the up/down button to choose your desire station to listen.
- Under FM mode, long press the **<OK/Tune>** button to scan the next available station, or press the **<OK/Tune>** button once, the use the up/down button to fine tune the frequency manually.

Alarm does not sound

- If you find the alarm does not sound after it is set, please check if the alarm icon appears on the display. If not, please check if the alarm mode is set to 'ON'. Remember to press the **Info/◀/Menu** button to exit the alarm setting to activate it.

Technical Specification

Model: DB-825C

Radio mode: DAB+/DAB/FM

DAB frequency range: 174.928MHz (5A) - 239.200MHz (13F)

FM frequency range: 87.5 - 108MHz

Audio output power: 1.5W x 2 (RMS)

Power input: 5V  1.2A

Power voltage: 100-240V~50/60Hz

Input sockets: 3.5mm earphone jack, 3.5mm Aux-in jack

Output socket: USB 5V 1A out, 3.5 mm audio out

Unit Dimension: 135 x 110 x 90 mm (L x D x H)

Remark: Specification may vary without notice

What's included in the box

- * DAB Radio
- * Power adaptor
- * User manual

WEEE and Recycling



The European laws do not allow any more the disposal of old or defective electric or electronic devices with the household waste. Return your product to a municipal collection point for recycling to dispose of it. This system is financed by the industry and the ensures environmentally responsible disposal and the recycling of valuable raw materials.

Ocean Digital Technology Ltd.
Flat B, 12/F., Yeung Yiu Chung (No.8) Ind. Bldg.,
20 Wang Hoi Road, Kowloon Bay,
Hong Kong
Email: support@oceandigital.com.hk