



Internet Radio with FM WR-18

User Manual



Please read this user manual carefully before using the receiver

Contents

1. Introduction to the WR-18 Internet Radio	4
2. Location of controls	6
3. Choosing modes and options	8
4. Battery Charging	9
5. Dimmer	10
6. Network Setup	11
7. Overview of Radio modes and functions	14
8. My Favorite	16
9. Internet Radio	17
10. Media Center	18
11. Storage	19
12. FM Radio	20
13. BT streaming	21
14. Timer	22
15. Sleep Timer	23
16. Configuration	24
17. Skytune Web Application for Internet Radio www.skytune.net	27
18. Problems and Solutions	30
19. Helpful Tips	32
20. Technical Specifications	33

1/ Introduction to the WR-18 Internet Radio

The WR-18 Internet Radio is a compact, multi-purpose and attractive portable radio with an internal 1800 mAh Lithium Polymer rechargeable battery for many hours of audio entertainment and a gateway into the world of digital audio.

There are seven different operating modes requiring different wireless connections as listed below:

- 1) My Favorite (Wi-Fi or Internet)
 - List of previously Preset (stored) favorite Internet Radio and FM radio stations
- 2) Internet Radio (Wi-Fi - Internet connected)
 - Internet Radio with more than 30 thousand radio stations worldwide
- 3) Media Center (Wi-Fi - No Internet)
 - Play music streamed over the Wi-Fi network by UPnP or DLNA server e.g. smart phone
- 4) Storage (No Wi-Fi or Internet)
 - Play audio entertainment from files stored on Micro SD memory card
- 5) FM Radio (No Wi-Fi or Internet)
 - Receive ordinary FM radio stations in your local area
- 6) BT streaming (No Wi-Fi or Internet)
 - Play audio transmitted from a Bluetooth source e.g. smart phone, laptop
- 7) Timer (No Wi-Fi or Internet)
 - To count down from a specified time with alarm

Introduction to the WR-18 Internet Radio

8) Sleep timer

- Enable the timer to turn the radio in standby after the selected time elapsed.

9) Configuration (No Wi-Fi or Internet)

- Set up options to personalize the radio and information center

Precautions

Charge the battery until the LED changes from Red to Green with a USB charger and the USB-C cable provided – do not apply any other power source or permanent damage to the radio may occur and be hazardous.



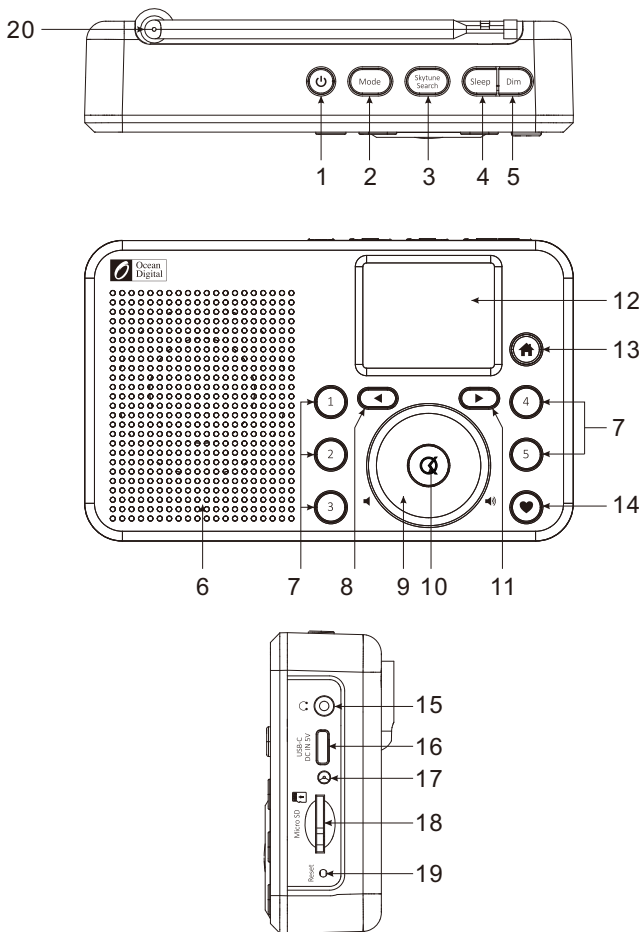

To clean use only a damp cloth and dry with a clean towel - keep away from all liquids.

To avoid loss of warranty do not attempt to repair or remove the cover for any reason.

2/ Location of Controls



Location of Controls

- 1) ON/OFF () - Press and Hold until display turns on or off
- 2) Mode – Switch between radio operating modes
- 3) Skytune Search – Enter keywords to find internet radio stations
- 4) Sleep – Setup delay timer before the radio automatically turns off
- 5) Dim – Turn on/off backlight; Press and hold for dimmer setup
- 6) Speaker – Loud speaker; turned off when earphone plugged in
- 7) Preset Buttons 1-5 – Press and Hold to add current audio source to Favorite list;
Press and release to recall favorite audio source
- 8) Navigation Control Left () – Move Back to previous display or item in lists
- 9) Dial Knob – Rotate to adjust volume, menus or station list
- 10) OK – Press and release to select function displayed or highlighted item in list
- 11) Navigation Control Right () – Move forward to next display or item in lists
- 12) Color Display – 1.77” color screen
- 13) Home () – Go to My Favorite mode or press and hold to go to EQ setup option list
- 14) My Favorite () – Go to favorite list or press and hold to add (preset) audio source to favorite list
- 15) Earphone Connector – Stereo 3.5 mm (can be used as Audio Out)
- 16) USB-C Connector – Battery charger; use USB-C cable provided
- 17) LED – Red LED = battery charging; Green LED = battery fully charged
- 18) Micro SD Card Slot – Playback audio files stored in MP3
- 19) Reset – Insert small pin (e.g. paper clip) to activate switch to turn the radio off
- 20) Telescopic FM radio antenna

3/ Choosing modes and options

All user input is information that the Radio uses to provide the desired audio entertainment and pressing the **OK** button a confirmation (Select) and go to command.

Once a desired selection is displayed or highlighted the selection is confirmed by pressing and releasing the **OK** button.



Navigate to modes (i.e. My Favorite, Internet Radio, FM radio, Media Center, Storage, Bluetooth, Sleep Timer or Configuration) or a position in a list by using the Navigation Control to Move Forward or Back until the desired mode is displayed or highlighted and press the **OK** button to confirm the selection.

Throughout this manual “Select” will mean navigating through display screens or option lists to display or highlight desired selection and confirming it by pressing and releasing the **OK** button.

4/ Battery Charging

The amount of battery charge is displayed with an indicator symbol () where all bars indicate a full or nearly full charge, one bar indicates low charge and flashes continuously at minimum charge as a reminder to charge the battery.

To charge the battery connect any USB charger (minimum charging capacity 1A) to the radio using the USB-C cable provided in the box. The battery charging symbol () will be displayed alongside the battery charge level symbol.

Battery charging LED (located on the RHS of the radio) will be Red while the battery is charging, turn Green when the battery is fully charged and the battery charge symbol () will change to () until the USB-C cable is disconnected.

The radio may be used while the battery is charging, however, this will cause the battery to take longer to fully charge.

The radio can be used with the USB-C cable connected indefinitely without causing any harm to the radio.

5/ Dimmer

By pressing the "Dim" button, the screen will turn off. It helps saving the power of the battery by turning off the screen. Press the "Dim" button again to turn it back on.

Entering the Dimmer settings by press and hold the "Dim" button.

Select Mode and option to use Normal or Power Saving setting.

- Normal – the display backlight will stay at the selected brightness level all the time without automatically changing to the dim level to save battery power.
- Dim – after a 20 second period of inactivity (i.e. no changes to the radio) the display backlight will change to the dim level.

Select Level and options to adjust Bright or Dim light levels

- Bright – Setup options to adjust the backlight in Normal mode
- Dim – Setup options to adjust the backlight in Dim mode

6/ Network Setup

The Internet Radio must have a high bandwidth internet connection and a wireless (Wi-Fi) home network connected to it to be fully functional.

To configure the Wi-Fi network connection turn on the radio by pressing and holding the power **On/Off** button until the display illuminates - this normally takes a few seconds.

The first time the Radio is turned on after leaving the factory a list of languages is displayed – navigate to and highlight a language by rotating the **Dial Knob** and press the **OK** button.

The display will change to ask if the configure network wizard should be started:

1) To setup the Wi-Fi network Highlight and Select Yes using the **Dial Knob** and **OK** button

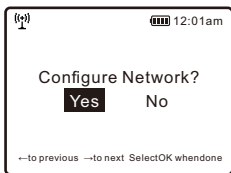

2) The display will change and display a list of options – select Add/Remove AP

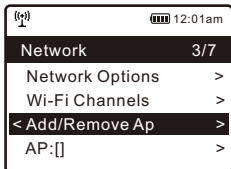

Network Setup

- 3) The display will change and display a list of options – Select Add AP (Scan)
- 4) The display will show a list of available networks (this may take a few seconds) – Select your network
- 5) The display will ask for your passphrase – this is often called passcode or password
 - Using the **Dial** Knob highlight the first character of your passphrase
 - Press and release **OK** button
 - Highlight the next character
 - Press and release **OK** button
 - Repeat highlighting characters and pressing the **OK** button until the last character is highlighted
 - While the last character is highlighted , press and hold the **OK** button until the display changes
- 6) If the connection is successful “Association Complete” will be displayed briefly.

To repeat the above procedure, or if Configure Network wizard does not automatically start, the network can be connected by using Configuration mode.

- 1) Press the Home button () to go to My Favorite mode
- 2) Navigate to and Select Configuration
- 3) Select Network

There are three different options to connect to the network from the Configuration mode:

Network Setup

1) Select Add/Remove AP (i.e. highlight and then press **OK** button) and repeat steps 1) through 6) above.

2) Select Add/Remove AP and then Select Add AP (WPS button) – Press WPS button on your router within 2 minutes to complete the connection.

– Select Add AP (Smart Config) – Using a smart phone or tablet download App EspTouch from iOS App Store or Android Play Store.

With the Radio and App device on the same network, select this option and start/launch the App. Select EspTouch.

The App will display the parameters of your network and ask for the network password. Enter the password and select "Broadcast" followed by "Confirm" when displayed on the App device.

If the network connection is successful "Association Complete" will be displayed briefly on the radio screen.

– To remove a previous network connection select "Remove AP" and delete the connection.

Connection status is displayed in the top left hand corner of the LCD with the Wi-Fi symbol and signal strength bars.



7/ Overview of Radio modes and functions

To Select any mode use the Home button () to display the My Favorite screen:



Navigate through the modes to find and Select any of these functions:

- 1) My Favorite – A maximum of 150 previously Preset (saved) favorite Internet Radio and FM radio stations are listed for Selection.
- 2) Internet Radio – Select online radio station from the thousands available on Skytune or by using the History list of previously selected radio stations or use Search to find a preferred radio station.
- 3) Media Center – Browse and Select music streaming on your home Wi-Fi network by any UPnP or DLNA compatible server e.g. Smart phone, Tablet, PC, Laptop.
- 4) Storage – Play audio entertainment from files stored in MP3 on a Micro SD card.
- 5) FM radio – Play your favorite local radio station using the telescopic antenna
- 6) BT streaming – When “Paired” (connected) to another Bluetooth device use the Radio as a powered speaker.

Overview of Radio modes and functions

Maximum range of the Bluetooth wireless signal is 10 meters (32 feet) but may be reduced by the presence of walls or other obstructions.

- 7) Timer – To count down from a specified time with alarm
- 8) Sleep Timer – Select a time delay before the Radio turns off while playing your selected audio entertainment source.
- 9) Configuration – This mode lists all available options and settings to personalize your Radio.

8/ My Favorite

Press and release the My Favorite button (♥) and display a list of up to 150 Internet Radio and FM radio stations that have been Preset (stored) for an easier and faster way to play favorite radio stations.

To add a radio station, at the end of the list, while it is playing press and hold my favorite button (♥) until the Preset symbol (⏏) is displayed in the top left corner of the LCD.

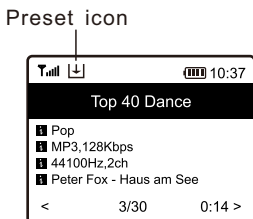

After the first 150 radio stations have been stored the next Preset will be stored in the first location, the next in the second location; continuing to overwrite each list location until looping back to the first location again.

To Edit the list highlight a list item, press the Move Forward button (►) to go to the Edit list function where the item can be moved Up, Down, Deleted, To Top or To End of the list.

For convenience there are 5 dedicated Preset buttons (labeled 1 – 5) to quickly and easily access the top five favorite radio stations. To Preset a station while it is playing press and hold one of the five buttons until the Preset symbol is displayed or to recall a station press and release the button.

9/ Internet Radio

Select Internet Radio mode (Home>My Favorite>Internet Radio>OK) and navigate the extensive list of worldwide radio stations using these options:

- 1) Skytune – Select a radio station using the structured lists that aid and reduce the task of finding the right station.
- 2) Use Search instead of browsing the extensive radio station list by searching with the initial letters of the desired station name, creating a shorter list of stations the more letters used in the search.
- 3) The History option will show a list of the radio stations recently selected. Every station played is added to the end of the list automatically until a maximum of 99 is reached when the next station selected will replace the first station in the list.

When playing Internet stations information about the station and what is playing will be displayed on the LCD screen. Pressing the Move Forward button once will display more information and pressing Move Forward again will display the time of day in 12 or 24 hour format depending on the time format selected in Configuration mode.

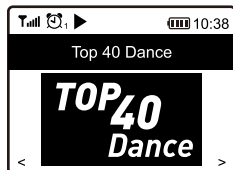
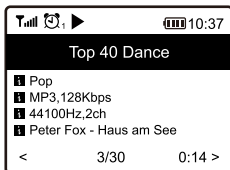

Radio Stations can be added to the My Favorite list at anytime a station is playing by pressing and holding a Preset (♥) button until the Preset symbol is displayed in the top left hand corner of the display.

10/ Media Center

The Radio supports the industry standard Universal Plug and Play (UPnP) and compatible with Digital Living Network Alliance (DLNA) standards.

These standards enable the Radio to browse and play media files located on UPnP or DLNA server provided the server has been setup to allow sharing of files, are streaming the files and connected to the same Wi-Fi network as the radio.

Select the Media Center mode to display a list of options:

- 1) UPnP – A scan is made to find UPnP and DLNA devices that are streaming on the Wi-Fi network (this can take a few seconds) and when complete options are listed to select music or playlists files. If no UPnP or DLNA servers are found “Empty List” is displayed.
- 2) My Playlist – Your own play list may be created by playing selected music and while it is playing pressing and holding a Preset button until the Preset symbol () is displayed.
- 3) Clear My Playlist – Select to delete all music files from My Playlist.

To start playing a streaming media file Select the server and other options (e.g. Music, Playlists etc.) in the lists displayed until the final option list is displayed when the media file will start playing automatically.

Media Center playback options (i.e. normal, repeat all, repeat once or shuffle) can be setup by selecting Home>Configuration>Playback Setup.

11/ Storage

The radio can play audio Files stored in a Micro SD card provided they are stored in MP3.

To play music from a Micro SD memory card, simply insert a micro SD card into its port on the side of the radio. Press the Home () or Mode button and navigate to "Storage", press **OK** to confirm. It will take a moment to read the micro SD card and show the stored file list before it can begin playing music.

Skip the next or previous track by rotating the **dial** knob and press **OK** to start playing music.

To pause/play the music, press in the **OK** knob.

Note: If a micro SD is not recognized or does not play properly, the list of files on the device is corrupted or a file in the list is not played, please format the memory card (all the files will be deleted) and try again.

Compatible audio format: Mp3

Capacity supported: up to SDHC at 32GB

NTFS and logical drive partitioning are NOT supported.

12/ FM Radio

Select FM Radio and press **OK** if option to Scan and Preset FM Stations is displayed or if a list of Preset FM stations is displayed highlight and select station to start listening.

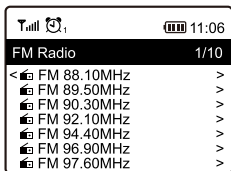

While a station is playing it can be added to the Favorite list by pressing a Preset button (♥) or to display more radio station information use the Forward button (►). Note: Changes to the available FM stations will not be automatically included in the available station list without a new scan for stations. To rescan go to Configuration > FM Setup > FM Full Scan.

For manual tune on the FM radio, press the button **OK** until “Tuning” is displayed in the lower right corner of the LCD screen. Pressing and releasing the Forward (►) or Back (◀) button to go up or down in frequency in small steps (0.1 MHz).

To exit manual tuning long press **OK** button.

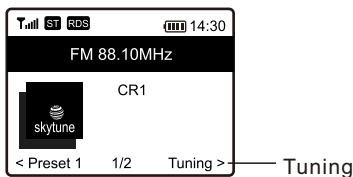

13/ BT streaming

After selecting Bluetooth the display will show the Radio's Bluetooth identifier code and connection status. If it is not connected "pairing" must take place with the audio source Bluetooth device.

When the Radio's identification code appears in the list of available devices on the audio source Bluetooth device pair the two devices so that they can recognize each other and will automatically connect whenever the Radio is in Bluetooth mode and within the maximum 10 meter (32 feet) range.

Once pairing is complete the audio file being transmitted by the source Bluetooth device will be received by the Radio and played the same as any other audio source.

Note that the radio Bluetooth is a "receive only" device that cannot transmit Bluetooth signal and cannot support devices such as Bluetooth earphones.

14/ Timer

Press the button  and use the button **OK** or the arrow buttons to select "TIMER".

Setting the Timer

The device offers the Timer function as a kitchen timer. The time will count down from a specified time and ends with a beeping sound. Timer settings is up to 99 hours, 59 minutes, 59 seconds.

The beeping sound volume and sound duration is adjustable from the Timer settings in Configuration menu.

Switching off the timer

When the alarm sounds, you can turn it off by pressing the button **OK**.

In case the device is switched to other menu rather than the Timer display when the alarm sounds, return to the Timer display in order to switch off the alarm.

15/ Sleep timer

While playing an audio source press and release the Sleep button on top of the radio and the display will show a list of different delay times. Select a time delay before the Radio automatically turns off allowing the listening of audio entertainment while falling asleep.

Selecting a delay time will automatically start the delay count down with the Sleep Timer symbol displayed in the top left hand side of the screen.

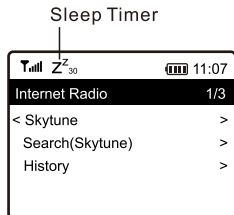

Use the Move Back control or Home button () to exit Sleep Timer setup.

16/ Configuration

Select Configuration for a list of options to personalize the radio to be displayed, navigate the list and select the desired function.

Network

Wi-Fi Network

- Network Options – Select if the Radio Wi-Fi should be permanently connected or to disconnect if the connection is not active for more than 30 seconds.
- Wi-Fi Channels – Select your location to minimize interruption (drop outs) of the audio stream e.g. music.
- Wi-Fi Network
 - Add/Remove AP – Scan local area to find and list available Wi-Fi networks
 - AP (WPS button) – Select this option to use automatic Wi-Fi connection by pressing the WPS button on the network router
 - Add AP (Smart Config) – Select this option to use App Esptouch to connect the radio to the network.
 - AP:[] – If the radio has been connected to more than one network use this option to select between networks
 - Signal – Display Wi-Fi signal strength in dBm
 - IP [current setting] – Factory Reset default is Dynamic
 - DNS [current setting] - Factory Reset default is Dynamic

Date & Time

Set up and select options for time zone, clock and date formats, adjust for day light saving time, network time, NTP server address. Default setting is local time using Internet time standard.

Configuration

You can also set clock style with choices between analog or digital clock display.

Language

Default is English or Select this option to setup the language for all displays.

FM setup

Options to select FM area, scan for FM stations to create station list and the display station list.

Local Radio

Automatically set local stations (default) or set manually to another location

Playback Setup

Media and Storage modes playback i.e. normal, repeat all, repeat once or shuffle

Resume play options

Play last when ready (default) or stay at Home display

Auto power save

To set the period time that is inactive for Power save to activate.

Dimmer

Options to set the display (LCD backlight) brightness levels in Normal and Dim modes. Set Dim and Bright light levels independently from dark to full brightness

Configuration

EQ [current setting]

Options for playback sound e.g. Flat, Rock, Classical

Buffer Time [current setting]

Select either a 2 or 5 second minimum amount of audio streaming data in the buffer (storage) before playing when recovering from breaks in the Internet data stream

Timer

This is to set the alarm sound volume and duration for the Timer function.

Information

Network and System information e.g. radio IP address

Software Update

Request an update to the radio software. Do not turn off the radio until the update has completed. If an error occurs or radio hangs up (i.e. becomes unresponsive) use a pin to activate the Reset switch inside the pin hole located on the right hand side of the radio near the bottom – the radio will turn off.

Reset to default

Reset all the Radio settings and options back to the exit factory condition

17/ Skytune Web Application for Internet Radio www.skytune.net

Use Microsoft Internet Explorer or Google Chrome web browser to manage My Favorite list or select Internet radio station for playback.

With the PC / Smart phone connected to the same Wi-Fi network as the radio go to web site www.skytune.net and click on "Browse / Search"

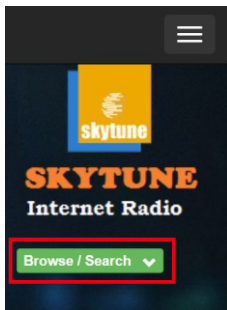

Browse or enter the name (e.g. Folk, Dance) to search for radio stations to create a list of radio stations.

Select a radio station by clicking on the heart symbol (♥) below the station name.

Result for Searching 'dance'



1.fm 90's
Dance



1.fm Dance
One



101.RU - Club
Dance



101.RU -
Russian Dance



Skytune Web Application for Internet Radio

www.skytune.net

Select either “Add favorite” or “Listen to Station” and enter the radio’s IP address. To find the IP address of the radio go to mode>Configuration>Information>Network Information>IP:

Add Favourite / Listen to Station ✕

Which operation do you want to apply to the station ?

1.fm Dance One

Add station to my radio device favourite

Listen to station on my radio device

Please enter your radio device's IP below.

192 . 168 . 1 . 11

Click on “Send” and the radio will start playing the radio station and the radio’s My Favorite list will be displayed on the web page. The station can be added to the list or the list edited using the tools on the web page with any changes automatically updating the radio’s My Favorite list.

Skytune Web Application for Internet Radio

www.skytune.net

MY FAVOURITE

Channel Name		URL						
1.	DJ AAM Radio FM	*****	Edit	Delete	Top	Up	Down	Bottom
2.	Country Radio Switzerlar	*****	Edit	Delete	Top	Up	Down	Bottom
3.	Bigbeat	*****	Edit	Delete	Top	Up	Down	Bottom
4.	24Radio Switzerland	*****	Edit	Delete	Top	Up	Down	Bottom
5.	AFN American Freedom	*****	Edit	Delete	Top	Up	Down	Bottom
6.	Energy Berlin	http://energyradio.de/bremen	Edit	Delete	Top	Up	Down	Bottom
7.	MP3 Pro	http://www.katrafm.com/katrafm_mp3pro.m3	Edit	Delete	Top	Up	Down	Bottom
8.	2	http://www.ultranet.biz/vegasandanski.m3u	Edit	Delete	Top	Up	Down	Bottom
9.	stream 2	http://lindowsradio.com:8600/listen.pls	Edit	Delete	Top	Up	Down	Bottom
10.	aac 128	http://eastlondonradio.com:8100/bighigh.aac	Edit	Delete	Top	Up	Down	Bottom
11.	Seoul Shoutcast	http://yp.shoutcast.com/sbin/tunein-station.	Edit	Delete	Top	Up	Down	Bottom

Add Channel	
Channel Name	URL
<input type="text"/>	<input type="text"/>
<input type="button" value="Submit"/> <input type="button" value="Reset"/>	

Adding a Radio Station

To add a Radio Station its name and URL can be entered into the Add Channel section along with selecting the Country where it is located and Genre of audio entertainment it provides.

You can also add the radio channel if you know the published audio stream URL with the streaming format as follow:

1. Audio formats: MP3, AAC, AAC+
2. Stream formats: Shoutcast, Icecast (HTTP, HTTPS) and HLS
3. Playlist formats: PLS, M3U
4. Sampling frequency: 44.1 KHz and 48 KHz

Request to add Radio Station

If you know the name of a Radio Station but it is not in the list a request can be made to have it added.

On the opening page select the Suggest Station tab and fill in the application.

18/ Problems and Solutions

Cannot connect to the Wi-Fi Network

a) Common Causes

- Incorrect passphrase / passcode / password for the selected Network.
- Location of the Radio has a weak Wi-Fi signal – if possible check with another Wi-Fi connected device in the same location or move to a location closer to the router.

b) Unusual Causes

- Incorrect Network security encryption – Radio supports WEP, WPA and WPA 2

Cannot play UPnP or DLNA Files

- There is no UPnP or DLNA server.
- The UPnP server is not streaming files over the Wi-Fi Network.
- The server is not correctly configured to allow sharing of files over the network
- The streaming device has a Firewall which is blocking access.

Internet Radio has interruptions (drop outs)

- Wi-Fi Channel interference – incorrect region selected
Configuration>Network>Wi-Fi Channels.
- Weak Wi-Fi signal – check the Wi-Fi symbol (top left hand side of LCD display) for a minimum of two “Bars” - add a Wi-Fi Extender to the Network if necessary.
- Radio Station has interrupted streaming – check by trying stations in the Skytune> Globe Most Popular list.

Problems and Solutions

- The Internet connection does not have sufficient bandwidth (capacity) to support all the devices connected to the Network when operating at the same time or is experiencing excessive error rates – have the Internet connection checked by the ISP (Internet Service Provider).

Internet Radio cannot play some stations

- The station may not be streaming – not all stations stream for 24 hours a day.
- There are too many users at this time – some stations have a limited number of users they can support at any given time.
- The station link is out of date – it is updated daily and should be correct the next day or access via Internet Radio > Skytune. Contact Ocean Digital support for more help.
- The station link is no longer active – the station is no longer available.
- The Internet connection between the radio and the radio station server (streaming device) is too slow or unstable to support the radio station data stream.

No Sound

- It is possible that the playback has stopped - press the OK button to resume playing
- Not all audio sources transmit at the same volume – turn up the volume
- Compare with a different audio source

Radio becomes unresponsive

The radio has a reset switch to turn it off in the unlikely event this occurs – insert a pin (e.g. paper clip) in the pin hole located on the right hand side of the radio near the bottom to activate the reset switch.

19/ Helpful Tips

The Internet Radio is streaming the audio source data from the selected radio station by the broadband modem / router and Wi-Fi network. Problems with the broadband connection (e.g. high error rate, Internet congestion due to overcrowding) will cause the radio to stop playing until the data stream starts again.

If the problem persists call the Internet Service Provider (ISP) and ask them to test the connection.

What is Buffering?

The digital audio data stream used to provide the sound (audio) when connected to a wireless network, router and the Internet. This data stream is transmitted in small bundles (packets) with the time interval between the packets changing all the time and turned into a smooth, continuous data stream by a Buffer that stores audio data to bridge the time gaps.

The buffer storage is limited and if the broadband connection is too slow or the Internet is overcrowded (i.e. anywhere starting at the radio station geographic location until it reaches the connection to the modem) errors and large gaps in the data packets can occur causing the buffer to run out of audio data and interruptions in the sound.

Similarly the Wi-Fi network shares its bandwidth (i.e. data capacity) with all the neighboring Wi-Fi networks and can become overloaded causing errors and interruptions in the sound.

The buffer will start to refill as soon as the data stream starts again and resumes playing after a short pause (i.e. 2 or 5 seconds adjustable in Configuration mode) to prevent constant starting and stopping of the sound.

20/ Technical Specifications

Model: WR-18

DC Power Input: 5 Volts 1 Amp. (USB-C)

Battery: 3.7 Volt 1800 mAh Lithium Polymer

Wi-Fi Wireless: IEEE 802.11b/g/n

(5 GHz only version ac – not supported)

Frequency: 2.4 GHz

Security: WEP, WPA, WPA2

Bluetooth Version: V4.2 BR, EDR Compliant

Frequency: 2.4 GHz

Range: 32 Feet (10 meters) Line of sight

Transmit Power: 0 dBm Receive only (not for earphones)

Storage: Micro SD card (maximum 32 GB) Mp3

Audio File Streaming Formats

UPnP: MP3, AAC, AAC+, WAV

DLNA: MP3, AAC, AAC+

Audio Output: 1 Watts

Analogue Output: 3.5 mm Stereo Earphone

Dimension: L130mm (5.12") x D29mm (1.14") x H80mm (3.15")

Weight: 232g

In the box

- * Internet Radio
- * User Manual
- * USB-C Cable

WEEE and Recycling



The European laws do not allow any more the disposal of old or defective electric or electronic devices with the household waste. Return your product to a municipal collection point for recycling to dispose of it. This system is financed by the industry and ensures environmentally responsible disposal and the recycling of valuable raw materials.

Ocean Digital Technology Ltd.

Flat B, 12/F., Yeung Yiu Chung (No.8) Ind. Bldg.,
20 Wang Hoi Road, Kowloon Bay, Hong Kong
Email: support@oceandigital.com.hk

FCC

This equipment has been tested and found to comply with the limits for a Class B digital device, pursuant to part 15 of the FCC Rules. These limits are designed to provide reasonable protection against harmful interference in a residential installation. This equipment generates, uses and can radiate radio frequency energy and, if not installed and used in accordance with the instructions, may cause harmful interference to radio communications. However, there is no guarantee that interference will not occur in a particular installation. If this equipment does cause harmful interference to radio or television reception, which can be determined by turning the equipment off and on, the user is encouraged to try to correct the interference by one or more of the following measures:

- Reorient or relocate the receiving antenna.
- Increase the separation between the equipment and receiver.
- Connect the equipment into an outlet on a circuit different from that to which the receiver is connected.
- Consult the dealer or an experienced radio/TV technician for help.

Caution: Any changes or modifications to this device not explicitly approved by manufacturer could void your authority to operate this equipment.

This device complies with part 15 of the FCC Rules. Operation is subject to the following two conditions: (1) This device may not cause harmful interference, and (2) this device must accept any interference received, including interference that may cause undesired operation.

RF Exposure Information

The device has been evaluated to meet general RF exposure requirement. The device can be used in portable exposure condition without restriction.